

Seismic ACADEMY

JOURNAL

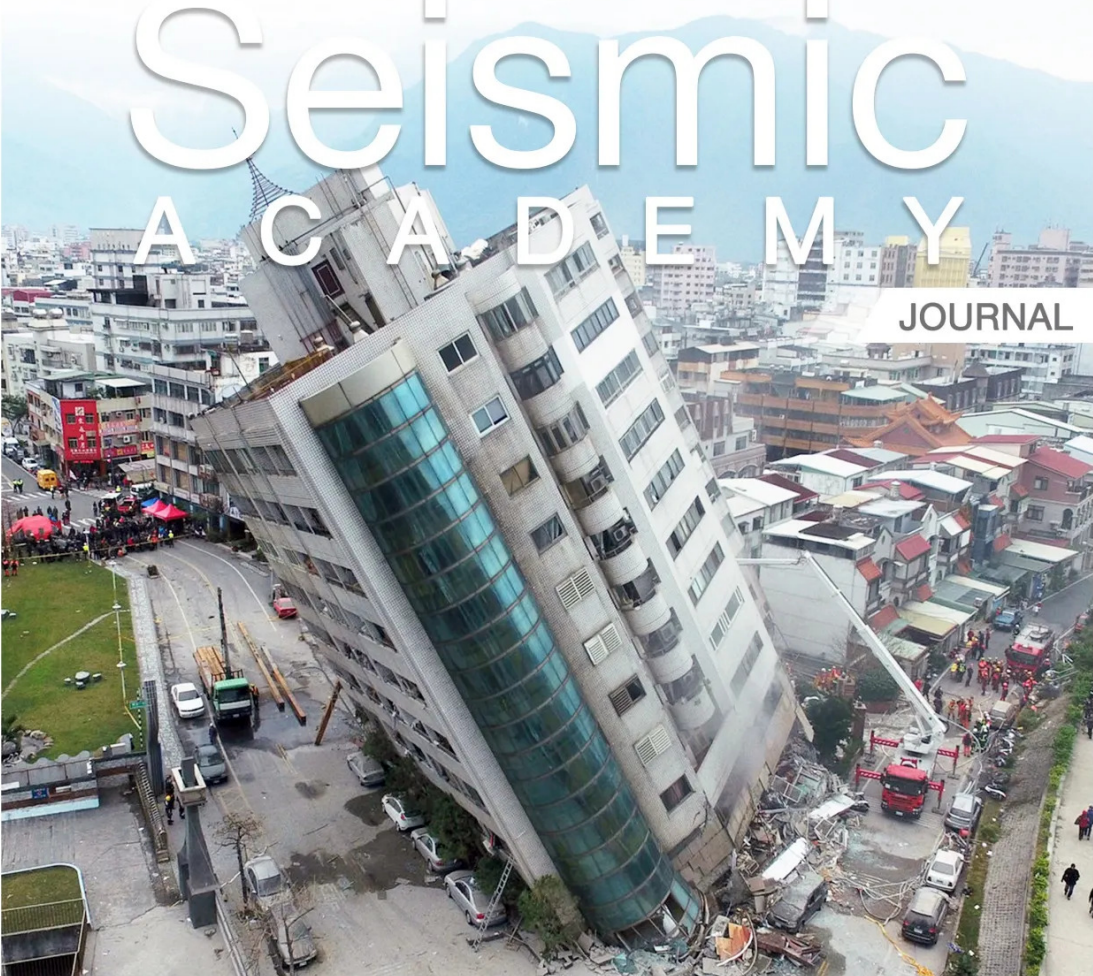

EARTHQUAKES

- Articles
- Events
- Seismic Splendour
- Recent Earthquakes
- Webinar Recap

Seismic Academy Journal

SEISMIC ACADEMY

A forum for professionals, academicians, authorities and industry experts to interact and disseminate knowledge on various aspects of earthquake engineering with different stakeholders, with an intent to increase awareness and develop their expertise on the subject.

OUR VISION

To make seismic academy as one source of information and use it for promotion of all seismic initiatives in our country.

OUR ADVISORY BOARD



Er. Jayant Kumar
Managing Director
Hilti India Pvt. Ltd.



Dr. S. M. Ali
Director General - Solar
Energy Society of India



Er. Vinay Gupta
Managing Director
Tandon Consultants Pvt. Ltd.



Er. Alok Bhowmick
Managing Director
B&S Engg. Consultants Pvt. Ltd.



Dr. Amit Prashant
Professor of Civil Engg.
& Dean of Research & Devt.
IIT Gandhinagar



Dr. Ajay Chourasia
Chief Scientist and Head
of Structural Engg. & 3D
Concrete Printing Group
CSIR-CBRI, Roorkee



Dr. Rajeev Goel
Chief Scientist & Head
Bridge Engg. & Strut. Div.
CSIR-CRRI, New Delhi



Dr. Durgesh Rai
Professor
Dept. of Civil Engg.
IIT - Kanpur



Er. Sangeeta Wj
Managing Partner
SD Engineering Consultants



Dr. Vasant Matsagar
Dogra Chair Prof.
Dept. of Civil Engg.
IIT Delhi



Er. Gangeswar Kawale
Member
MEP Engineers Associations

“The information and views expressed in articles published in Seismic Academy Journal are those of the authors and Seismic Academy takes no responsibility regarding the same. No part of this publication may be reproduced by any means without prior written permission from Seismic Academy.”

IN THIS ISSUE - Total No. of Pages: 44 (Including Cover)

A **CE&CR** PRODUCTION

For further information, contact -

Shounak Mitra, Head - Codes & Approvals (Fastening), Hilti India Pvt. Ltd.

M: 9899732127 | E: support@theseismicacademy.com

FROM THE DESK OF ADVISORY BOARD

The Kahramanmaraş Turkey earthquake, affecting a total of eleven provinces, causing significant damage to buildings and infrastructure and claiming the lives of dozens of people. This activity raised concern of engineering community in India to become Seismic Resilient country, as Indian subcontinent has suffered some of the greatest earthquakes in the world. Given current construction practices and the lack of an adequate regulatory framework to manage such construction, the seismic risk in India is growing rapidly. There is dire need to focus on following issues:

- 1. Licensing of Engineers:** Currently in India there is no formal system of competence-based licensing of structural engineers. There are no requirements for continuing education and there are limited opportunities for a typical engineer to remain up-to-date with technical subjects. Professional licensing serves several purposes: (a) ensuring competence of professionals, (b) enhancing quality and accountability of professionals since the council can withdraw the licence to practise in case of misconduct or incompetence, and (c) increasing the mobility of professionals from one jurisdiction to another.
- 2. Professional competence:** India has many great engineers and architects, but in a country of its size, there are also many engineers and architects who lack the adequate skills and expertise necessary to practise good structural engineering. In the absence of competence-based licensing, without adequate supervision by competent experienced engineers, and with no additional layers of checking the drawings, an engineering graduate may often design and sign drawings that have fatal errors. The computer tools available for analysis and design of structures have compounded the problem further. Many engineers tend to take the computer program as the ultimate engineer and either do not



Dr. Ajay Chourasia
Chief Scientist and Head
of Structural Engg. &
3D Concrete Printing Group
CSIR-CBRI, Roorkee

“
**The computer
tools available for
analysis and design
of structures have
compounded the
problem further.**
”

have the time or the capability to ensure that the design and details coming out of a computer analysis make sense.

- 3. Building code enforcement:** Different cities have different requirements for the issuance of building permits and typically require a certificate from an engineer and/or an architect that the building complies with all the codes and is structurally safe. Not many municipalities require even submission of structural drawings, and some may ask that a building of a certain size be proof checked and certified by another engineer. Unfortunately, municipalities do not have a similar system for checking for structural safety for a variety of reasons: (a) the need for enforcement of structural safety has not always been emphasized by professionals to the administrators, (b) there is concern that such enforcement will cause corruption rather than solve the problem of structural safety, and (c) the engineering staffs associated with municipalities lack a structural engineering background and temperament since most often they handle problems of drainage, water supply and unauthorized constructions.
- 4. Construction typologies:** Most urban construction in India consists of either masonry load-bearing buildings of up to three or four storeys, or reinforced concrete frame buildings with masonry infills as walls. Their safety can be significantly enhanced by (a) adopting confined masonry construction in the case of masonry load-bearing constructions and (b) providing reinforced concrete shear walls in the case of reinforced concrete frame buildings.
- 5. Seismic retrofitting of existing buildings:** Need for the retrofitting of public buildings, important buildings, very unsafe buildings, etc. is of paramount importance. Some issues that give context to retrofitting in India are: cost of retrofit, method, competency, technique of retrofit, time required for retrofitting, prioritisation and education.



National Conference on Futuristic Structural Engineering

StructE NatCon 2024

8-10 November, 2024
PHD House, New Delhi

Organised by



Indian Association of
Structural Engineers

www.structenatcon.com

Important Dates

Submission of Abstracts: 15 July'24 (Extended)

Acceptance Intimation: 31 July'24

Early Bird Registration (10% Discount): 15 Sept. 24

Early Bird Registration (20% Discount): 15 July 24

Full paper submission: 31 August 24

Regular Registration: 31 October 24

**Publishing
Partner**



TABLE OF CONTENTS

INTERVIEW

Anurag Sinha

Executive Director

Engineers India Limited..... 06

EARTHQUAKES UPDATE..... 07

ARTICLES

Increasing the Safety of Structures Using Base Isolation

By Dr. N. Subramanian..... 09

Isolation Bearings for arch Bridge, MuMBal coastal road Project

By Santanu Majumdar & Santanu Adhikary..... 18

Breathing Life Into Existing Structure - Enhancing Safety of A Chemical Plant

By Aishwarya Gupta 32

WEBINAR RECAP

Emerging Technologies on Earthquake Resilience 24

SEISMIC SPLENDOUR

The Torre Mayor

A Pinnacle of Seismic Engineering in Mexico City..... 37

EVENT UPDATE

The Seismic Shift

Seismic Academy Annual Conference 2024..... 42



Anurag Sinha
Executive Director
Engineers India Limited



Seismic Academy is doing a formidable task in bringing various topics of practical importance specially with respect to seismic safety of structures.



out. Well established practices are in place, also for the seismic re-qualification for codal compliance due to revision in codes from time-to-time.

Seismic Academy: Does Engineers India Limited engage in collaborative efforts with other institutions or experts specializing in seismic research and development to ensure that your team of engineers remain conversant with the evolving standards and technologies?

Anurag Sinha: Close collaboration with BIS, CBRI, IITs and other professional bodies like ICI, ACI, etc. ensures knowledge sharing. Further, participation in various conferences, seminars, etc. also ensures updation with the state-of-the-art technologies.

Seismic Academy: What are the company's strategic objectives for innovation and sustainability over the forthcoming five-year period?

Anurag Sinha: Focus is on contribution towards Net Zero and the Sustainable Development Goals.

Seismic Academy: How does Engineers India Limited intend to navigate and address prospective challenges within the engineering and construction sectors?

Anurag Sinha: Focus is on utilising the power of AI & ML along with utilising BIM & DigitalTwin.

Seismic Academy: How do you see Seismic Academy contribute to enhancing the overall knowhow on the topic and be a partner to your in-house training programs?

Anurag Sinha: Seismic Academy is doing a formidable task in bringing various topics of practical importance specially with respect to seismic safety of structures. In India significant amount of non-engineered and engineered seismically inadequate structural construction are prevalent. Awareness and initiative of safe practice is paramount, which can possibly be a collaborative effort.

Seismic Academy: Your recommendation for the practicing engineers and the budding engineers.

Anurag Sinha: Take pride in being a structural engineer by having thorough knowledge of national codes related to structural engineering. Understanding the code clauses before blindly following the same. Study of reference materials, attending various seminars, conferences in this regard. And lastly, let structural engineering not governed by Architects and Developers.

Seismic Academy: Given the increase in seismic vulnerability of the country, how do you ensure the seismic safety of all your projects, apart from adherence to the regulatory codes?

Anurag Sinha: Apart from the adherence to the regulatory codes, a site-specific seismic spectra is generated and utilised for analysis & design to enhance the accuracy.

Seismic Academy: What cutting-edge technologies are employed by the company to bolster the seismic resilience of the structure? Can you delineate instances where advanced seismic technologies have been adeptly implemented?

Anurag Sinha: Since the primary system itself is designed for seismic resilience, additional/ advanced technologies are seldom required.

Seismic Academy: Do you have in place any comprehensive processes that you utilize for the seismic evaluation of already completed projects?

Anurag Sinha: Seismic evaluation of numerous buildings & structures for National & International Clients have been carried

RECENT TEMBLORS AROUND THE WORLD!



18th
July '24

ANTOFAGASTA, CHILE

Magnitude: 7.4

The U.S. Geological Survey reported, shaking homes and causing power outages. There were no immediate reports of injuries or major damage.

2nd
April '24

HUALIEN CITY, TAIWAN

Magnitude: 7.4

Damages: At least 18 people were killed and over 1,100 were injured in the earthquake. It is the strongest earthquake in Taiwan since the 1999 Jiji earthquake, with three aftershocks above Mw 6.0. The Central Emergency Operation Center reported at least 2,498 cases of damage nationwide following the earthquake, with 1,140 instances in Taipei, 497 in New Taipei and 366 in Hualien County. At least 111 structures were destroyed.

28th
June '24

ACARÍ, AREQUIPA, PERU

Magnitude: 7.2

Damages: None reported

11th
July '24

SANGAY, PHILIPPINES

Magnitude: 7.1

Damages: None reported

2nd
April '24

MAUG ISLANDS REGION, NORTHERN MARIANA ISLANDS

Magnitude: 6.8

Damages: None reported

26th

May '24

FANGALE'OUNGA, TONGA

Magnitude: 6.6

Damages: None reported

14th

April '24

KIMBE, PAPUA NEW GUINEA

Magnitude: 6.5

Damages: None reported

27th

July '24

BONIN ISLANDS, JAPAN

Magnitude: 6.5

Damages: None reported

11th

July '24

TOFINO, CANADA

Magnitude: 6.4

Damages: None reported

24th

June '24

PORT-OLRY, VANUATU

Magnitude: 6.3

Damages: None reported



Reference -

- <https://riseq.seismo.gov.in/riseq/earthquake>
- <https://earthquake.usgs.gov/earthquakes/browse/significant.php>
- <https://earthquaketrack.com/>

INCREASING THE SAFETY OF STRUCTURES USING BASE ISOLATION

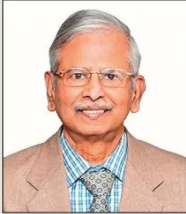

Dr. N. Subramanian
Ph.D., FNAE, F.ASCE

INTRODUCTION

More than 65% of the land area of India is prone to moderate to severe earthquake shaking, and there are several important infrastructures built in these areas. To safeguard these structures, earthquake resistant design is essential. In contrast to conventional approach of earthquake resistant design, wherein damage is expected to occur in select structural members, the approach adopted in critical infrastructure and important buildings is to eliminate damage to a considerable extent through the use of base isolators. The concept of base isolation is to use base isolators between the foundation and the superstructure, such that the superstructure is isolated from the ground. (This concept is similar to the provision of neoprene bearings at the supports below the bridge decks). Buildings resting on such base isolators are called base isolated buildings. It has been observed from past experience that base isolation systems are more effective for buildings with following conditions: a) stiff superstructure, b) rigid foundation on stiff soil, c) ground motions that do not have sharp pulse-like motions, and d) ductile detailing of the whole structure [IS 1893-Part 6 (2022)].

Seismic isolation systems prevent seismic energy from entering buildings by using devices

made from rubber or steel plates coated with a friction-generating material that slide over one another to minimize the effect of an earthquake. These isolation devices are installed between the building's foundation and the building (See Fig. 1). Alternatively, seismic dampers, installed in each story of a building, could absorb earthquake energy the way shock absorbers work in a car and convert it into heat energy to minimize damage.

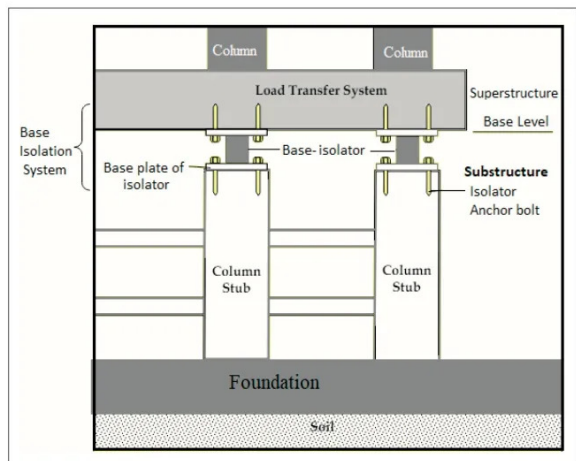

Fig. 1 Sectional elevation of a base isolated building

THE CONCEPT OF BASE ISOLATION

The basic elements of a base isolation system are shown in Fig. 2(a); the supplemental dampers shown are optional and hence may or may not be utilized within an isolation system. These dampers absorb energy and thus increase the damping of the building (Subramanian, 2016). By decoupling the structure from ground shaking, isolators reduce the level of response in the structure that would otherwise occur in a conventional, fixed-base building (see Fig. 2b). Conversely, base isolated buildings may be designed with a reduced level of earthquake load to produce the same degree of seismic protection. Qualitatively, a conventional

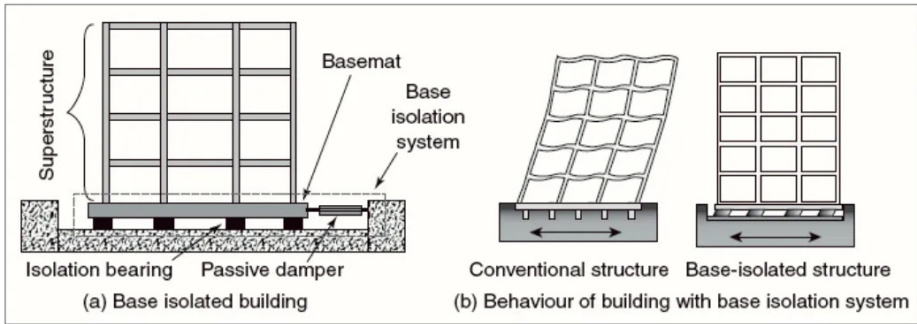

Fig. 2 Concept of base isolation (Source: Subramanian, 2016)

structure experiences deformations within each storey of the structure (i.e., inter-storey drifts) and amplified accelerations at upper floor levels. In contrast, base isolated structures will experience deformation primarily at the base of the structure (i.e., within the isolation system) and the accelerations are relatively uniform over the height of the building.

Typical acceleration design response spectra for three different damping levels are shown in Fig. 3(a). The major effect of seismic isolation is to increase the natural period which reduces the acceleration and thus force demand on the structure. Thus the forces induced by ground shaking will be much smaller than those experienced by 'fixed-base buildings' directly resting on the ground. In terms of energy, an isolation system shifts the fundamental period of a structure away from the strongest components in the earthquake ground motion, thus reducing the amount of energy transferred

into the structure. The energy that is transmitted to the structure is largely dissipated by efficient energy dissipation mechanisms within the isolation system.

However, as shown in Fig. 3(b), softer soils tend to produce ground motion at higher periods which, in-turn, amplifies the response of structures having high periods. Hence, seismic isolation systems should not be used in sites with soft soils, such as those present in the Mexico City, where the fundamental natural period of soft soil is found to be approximately 2s. Thus, base isolation systems are most effective on structures built on stiff soil and on structures with low fundamental period (low-rise building); on the other hand they are least effective on structures built on soft soil and on structures with high fundamental period (tall building).

The first structure which used the principle of base isolation is believed to be the Tomb of

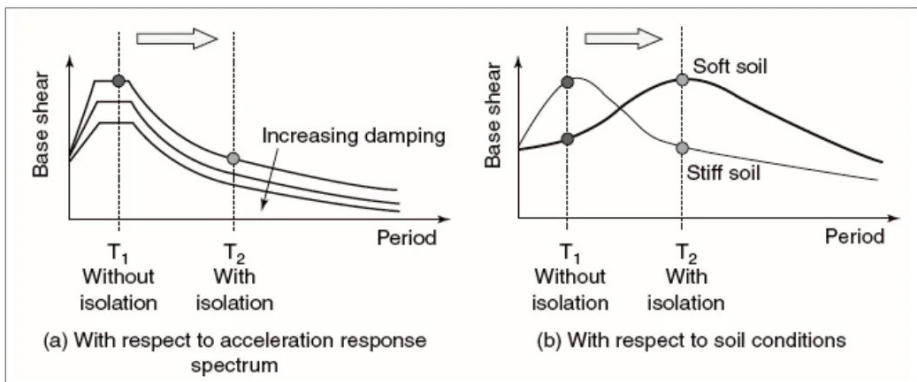

Fig. 3 Effect of seismic isolation (Source: Subramanian, 2016)

Cyrus in Pasargadae, a city in ancient Persia (now Iran) in the 6th century BC. However, the American architect, Frank Lloyd Wright, was the first person to implement some kind of base isolation technique in the Imperial Hotel structure at Tokyo. He provided closely spaced short length piles in the top 2.5 m layer of firm soil that covered a deep deposit of shaly mud. The building survived the devastating 8.3 magnitude 1923 Tokyo earthquake, while other buildings around it collapsed (But eventually the foundation sank irrecoverably into the silt, and the structure was demolished in 1968).

The present day modern base isolation devices started with the pioneering work done by R. Ivan Skinner, W.H. Robinson, and G.H. McVerry at the Physics and Engineering Laboratory of the Department of Scientific and Industrial Research (PEL, DSIR) in New Zealand during 1977 (they used the World's first isolator developed by them in the William Clayton Building, New Zealand) and later by Prof. James M. Kelly at the University of California at Berkeley. The first base isolated building in the United States is the Foothill Communities Law and Justice Center, about 97 km east of downtown Los Angeles. Completed in 1985, the building is four stories high with a full basement and sub-basement for the isolation system, which consists of 98 high-damping elastomeric bearings. The superstructure of the building has a structural steel frame stiffened by braced frames in some bays. Now, more than 1500 structures in the USA have been seismically isolated (www.northernarchitecture.us). The 300-bed district hospital in Bhuj, is the first in India to

be installed with 280 lead-rubber and sliding bearings, which was constructed after the Bhuj earthquake in January 2002 (this hospital replaced the one that collapsed tragically in the Bhuj earthquake).

The first large base isolated building in Japan was completed in 1986. Since the Kobe earthquake, more than 2000 base isolated buildings (many of them apartment blocks) were constructed in Japan. It is estimated that the total number of buildings with seismic isolation in Japan till April 2015 is 7800 (Walters 2015). Base isolation is being adopted in several buildings all over the world. As per Walters (2015) more than 4000 buildings in China have been equipped with base isolators. The application of this technology to multi-storey buildings is also becoming popular, but requires very large isolators.

Isolators of up to 1,600 mm diameter and around 600 mm height are currently available, a size capable of sustaining over 20 MN axial load and 800 mm shear displacement (Nishi et al. 2009). In addition to buildings, seismic isolation has been used for the seismic protection of structures such as bridges, liquefied natural gas (LNG) tanks, and offshore platforms.

The performance of this technology was verified during the 1994 Northridge earthquake of California, USA, the 1995 Kobe earthquake of Japan, as well as the 2008 Sichuan earthquake of China. For example, a California hospital remained operational, unlike other conventionally built structures in the area (Nishi et al. 2009).

TYPES OF BASE ISOLATION SYSTEMS

Many types of isolation system have been proposed and have been developed to varying stages, with some remaining only in concepts and others having installed in several projects. Fig. 4 shows the various types of base isolation systems; they may be broadly classified as (a) elastomeric bearings (lead-rubber bearing, high-damping natural rubber bearing, low-damping natural or synthetic rubber bearing, low damping natural rubber with lead core), (b) sliding bearings (flat sliding bearing, spherical

“ More than 1500 structures in the USA have been seismically isolated. ”

sliding bearing, friction pendulum systems), (c) sliding/friction bearing, (d) rolling systems (using cylindrical rods or elliptical bearing), and (f) combined systems (examples are the Électricité de France system used in nuclear power plants in France and the resilient-friction base isolators). Some of the frequently used isolator systems are shown in Fig. 5.

The Elastomeric bearing is the most common type of base isolation device, and consist of alternating rubber and thin steel plates layers (about 3 mm thick), firmly bonded to each other (Figs 5a and 5b). The bearings are constructed by placing un-vulcanized rubber sheets and steel shims in a mold, then subjecting the mold to elevated temperature and pressure to simultaneously vulcanize and bond the rubber. The steel plate reinforcement provides

a high compressive stiffness to reduce vertical deflection under the heavy weight of the structure, making the isolator stable. The rubber layers provide the very low horizontal stiffness needed to give the structure a horizontal natural frequency (typically 0.5 Hz), lower than the peak frequencies of an earthquake (Nishi et al. 2009). This decouples the structure from ground shaking, reducing the transmission of earthquake forces into the structure and protecting both the structure and its contents (50–85% reduction has been achieved). In addition, a rubber cover is provided on the top, bottom, and sides of the bearing to protect the steel plates. In some cases, a lead cylinder is installed in the center of the bearing to provide high initial stiffness and a mechanism for energy dissipation.

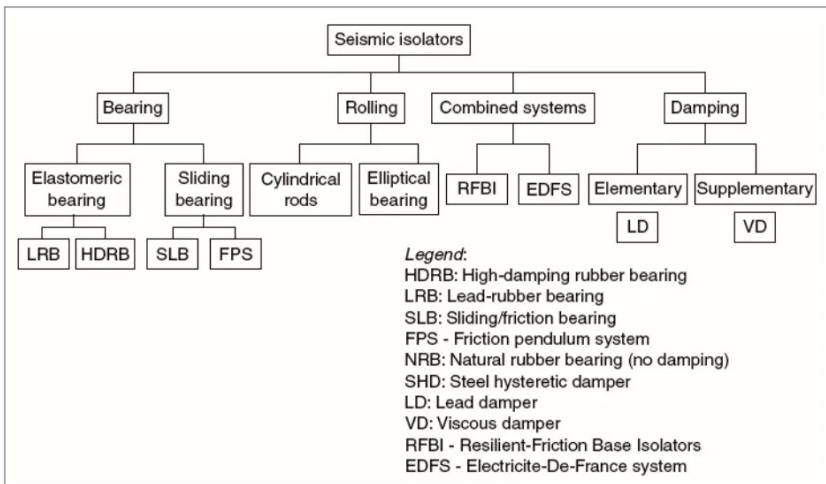

Fig. 4 Types of seismic isolators (Source: Subramanian, 2016)

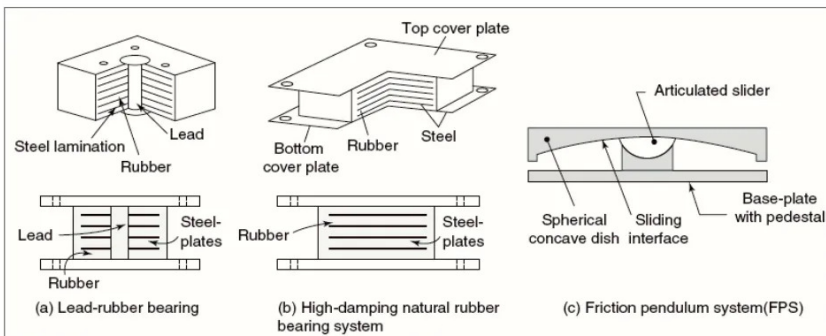

Fig. 5 Common types of seismic base isolators (Source: Subramanian, 2016)

The Lead-rubber bearings (LRB) were first introduced and used in New Zealand in the late 1970s. They differ from low-damping natural rubber bearings only by the addition of a lead-plug that is press-fit into a central hole in the bearing. The lead-plug deforms plastically under shear deformation, enhancing the energy dissipation capabilities compared to the low-damping natural rubber bearing (see Fig. 5a). After the lead yields, it dissipates energy as it is cycled. Fatigue of the lead is not a concern since lead recrystallizes at normal temperatures. During a large earthquake, a shear (horizontal) displacement of several hundred millimeters may be imposed on the isolators. The rubber layers provide the large shear deformation capacity needed. The service life of the isolators is anticipated to be at least several decades.

Sliding bearings typically utilize either spherical or flat sliding surfaces. The friction pendulum system (FPS) bearing utilizes an articulated slider that moves horizontally on a spherical dish-shaped surface and is used extensively in the United States. Usually, the sliding surface is oriented concave down to minimize the possibility of debris collecting on the sliding surface (see Fig. 5c). The articulated slider is faced with a Teflon coating. Under horizontal motion the spherical concave dish displaces horizontally relative to the articulated slider and base-plate. Friction between the PTFE type material and stainless steel surface provides frictional resistance and energy dissipation, whereas the radius of curvature of the spherical concave dish provides a restoring force. The most recently developed triple friction pendulum version of FPS, patented and manufactured by

Earthquake Protection Systems, Inc., contains a compound articulated slider with multiple sliding surfaces to allow control of the sliding sequence and the resulting hysteresis curve (Walters 2015).

Mayes et al. (2012) compared the cost-benefit analysis of isolated and non-isolated buildings and concluded that considering the cost of earthquake insurance premiums, using base isolation without earthquake insurance can be a more cost-effective solution than a conventional fixed based structure with insurance, despite the high cost premium for base isolation.

PERFORMANCE OF BASE ISOLATED BUILDINGS IN THE 2023 TURKEY & SYRIA EARTHQUAKES

On Feb. 6, 2023 at 4:17 am local time, a 7.8-magnitude earthquake struck near the city of Kahramanmaraş, Turkey, as a result of complex fault rupture with a total length of about 400 km. Nine hours after that, a second 7.5-magnitude earthquake struck again, 60 miles north of the first one, with a total fault rupture of about 190 km. This sequence of shallow earthquakes together with their numerous aftershocks caused widespread devastation, killing over 50,000 people and with more than 200,000 building collapsing or heavily damaged over a vast region in southern and central Turkey (Sönmez et al., 2023). The modern reinforced concrete design specification in Turkey (TS 500) was enacted in 2000. This state-of-the-art code mainly resembles ASCE 7 for the design of new buildings and follows ACI 318 code clauses. However most of the buildings that collapsed are pre-2000 buildings which were more vulnerable to earthquakes due to the inadequacy of the older seismic design code, the lack of construction inspection, and poor quality of materials used (Sönmez et al., 2023).

These earthquakes also tested advanced building technologies that were used to minimize damage and keep buildings functioning after a quake. Several hospitals built with seismic isolation system survived the earthquakes with almost no harm, according to local news reports, even while surrounding buildings sustained heavy damage. For example, the Adana City

“

During a large earthquake, a shear (horizontal) displacement of several hundred millimeters may be imposed on the isolators.

”

Hospital, shown in Fig. 6, survived the earthquake without damage. It also had instrumentation to record both ground shaking and the building's response. Thanks to its seismic isolation system, the building saw a 75% reduction in shaking, according to the company that designed the isolation system, compared with neighboring structures. This system allowed this hospital building to stay up and running during and after the earthquake. Ref. 14 provides the details of the ten largest base isolated buildings in the world.



Fig. 6 The Adana City Hospital in Turkey with a seismic isolation system helped it to stay up and functioning during and after the earthquake (Source: Ref.13)

SOME PROBLEMS OF CURRENT BASE ISOLATOR SYSTEMS

It has to be noted that normal base isolation systems provide only horizontal isolation and are rigid or semi-rigid in the vertical direction. A rare exception to this rule is the full isolation (horizontal and vertical) of a building in southern California isolated by large helical coil springs and viscous dampers (Kircher 2012). The implementation of the base isolation requires optimal design, which depends on the magnitude and frequency range of the earthquake that is being considered. Recent research reveals that the base isolation system may be vulnerable for buildings situated in the near-fault and far-fault earthquakes zones. Near-fault earthquakes with a large displacement and long-period pulse, such as the 1994 Northridge earthquake, may lead to over-stretching of isolator and resulting in malfunctioning of the system (Jangid and Kelly 2001). While far-field earthquakes (with its low-frequency components falling into the resonant region of

the conventional base isolation system) may result in amplification of destructive responses to the protected structures.

INDIAN CODE ON BASE ISOLATION

Several codes have been developed for the specification and design of seismic isolation devices such as AASHTO (2014), EN 15129:2018R, ISO 22762-1 (2018), ISO 22762-3 (2010), and ISO 22762-4 (2014). The Bureau of Indian standards issued the code IS 1893 (Part 6) Criteria for Earthquake Resistant Design of Structures: Part 6 Base Isolated Buildings in February 2022. This standard provides guidelines for the estimation of design lateral force and displacement to be considered in the design of buildings with base isolation system, method of structural analysis to be adopted in the analysis of such buildings and guidelines for testing of the seismic isolation devices that are used in such buildings. According to this standard, the base isolated buildings are expected to perform better than conventional fixed base buildings, during moderate to severe earthquakes. As per this code, ductile detailing of the whole structure is necessary, even in base isolated buildings. This standard may also be used for the design of base isolation system for existing buildings, as part of earthquake retrofitting. In such cases, full dynamic analysis has to be done to determine the performance of the building.

As per this code, base isolated building should be designed considering seismic zone, site characteristics, vertical acceleration, gross cross-section properties, occupancy,



Recent research reveals that the base isolation system may be vulnerable for buildings situated in the near-fault and far-fault earthquakes zones.



configuration, structural system, and height as per IS 1893 (Part 1). Base isolated buildings should be located at sites that have Soil Types I and II as classified in IS 1893 (Part 1). Additionally, even where Soil Types I and II are found, it should be ascertained that there is no possibility of liquefaction. All base isolator units should be firmly anchored to the substructure and the superstructure. The forces in the connecting elements should not exceed their design strength as per IS 800 for structural steel members and as per IS 456 for reinforced concrete members.

The code does not allow any tensile load in any base isolation device. When tensile loading occurs, the maximum tensile stress should be restricted to the shear modulus of the base isolator. Additionally, in such cases the response history analysis should be used (including the effect of vertical component of earthquake forces). The factor of safety against overturning at the base of the substructure should not be less than 1.4 and that against sliding should not be less than 1.2.

Only regular buildings as per IS 1893 (Part 1) should be attempted to have base isolation. In addition, the centre of resistance along two horizontal plan directions of the base isolators should coincide with the centre of resistances of the substructure as well as the super structure. Services and utilities that cross the isolation interface should be designed and detailed to accommodate the total displacement without disruption in their functionality.

“

Where Soil Types I and II are found, it should be ascertained that there is no possibility of liquefaction.

”

SEPARATION FROM THE ADJACENT BUILDING AND LOCATION OF MOAT

The wall of the moat of a base isolated building should be placed at a distance not less than the total design displacement Δ_D of the base isolator units, estimated as per clause 6.1.4 of IS 1893-Part 6. When two base isolated buildings are adjacent to each other, the minimum clear distance between them should be equal to the sum of the design displacement plus two times the total lateral displacement of each building, estimated as per clause 6.1.8 of IS 1893-Part 6. A base isolated building should be separated from an adjacent building (whether base isolated or not) by a distance greater than the design displacement Δ_D plus the separation distance specified in clause 7.11.3 of IS 1893 (Part 1).

LOCATION OF BASE ISOLATORS

All base isolators in a building should be placed at a single level such that their top levels are in the same horizontal plane. When isolators are placed on column stubs, the maximum height of the column stubs below the isolators shall not be more than 2.5 m. It is required to have adequate space for inspection, both during installation and later for replacement of these base isolator units. In addition, it should be ensured that the base isolators are protected adequately in case of fire, flooding or freezing.

METHODS OF ANALYSIS

The IS 1893 (Part 6) code allows both the equivalent static method, and the response spectrum method for the structural analysis of base isolated buildings to arrive at the design lateral displacement and the design lateral force of the isolation system. However, while using the equivalent static method all of the following conditions should be satisfied:

- The building is not located within 20 km from any known active fault;
- The building rests on Soil Type I or Soil Type II, as per IS 1893 (Part 1);
- It has a height of 20 m or less above the base level;
- The effective natural period T_{eff} of the building is less than 3.0 s;
- The effective natural period T_{eff} along the considered direction of shaking is more

than three times the fundamental natural period T of the corresponding fixed-base building;

- The base isolation system meets all of the following three criteria: (1) Its effective stiffness at the design displacement is more than one-third of its effective stiffness at 20 percent of the design displacement; (2) It is capable of re-centering after the earthquake; and (3) It possesses force-displacement characteristic independent of the rate of cyclic loading.
- The structure is located in Seismic Zone II only; and
- The structure conforms to the configuration regularity criteria as per IS 1893 (Part 1).

Due to these restrictions, it is always preferable to use the response spectrum method for the structural analysis. The IS 1893-Part 6 code may be referred for the other clauses pertaining to the use of the response spectrum method. In addition, the IS 1893-Part 6 code also specifies several full-scale testing of select samples of base isolators. In addition, the code mandates that two test isolators, similar to those used in any project should be kept at the site and subjected to the same environmental conditions. The test isolators should be tested after 15 years of installation and then 3 years thereafter to check the impact of aging and deterioration on the mechanical properties.

More information on seismic base isolators, analytical and numerical models, other code provisions for seismic isolation, buckling and stability of isolators, design examples, computer applications, and recent trends may be found in Kelly (2012), Kircher, 2012, Naeim and Kelly (1999), Skinner et al. (1993), Walters (2015), and Zhou and Xian (2001).

SUMMARY AND CONCLUSIONS

In contrast to conventional approach of earthquake resistant design, wherein damage is expected in select structural members, the approach adopted in critical infrastructure and important buildings is to eliminate damage to a considerable extent through the use of base isolators. Base isolators are passive structural control systems, and are installed between the building's foundation and the super-structure.

“ Base isolators are passive structural control systems, and are installed between the building’s foundation and the super-structure. ”

By decoupling the structure from ground shaking, isolators reduce the level of response in the structure that would otherwise occur in a conventional, fixed-base building. Base isolated structures will experience deformation primarily at the base of the structure (i.e., within the isolation system) and the accelerations are relatively uniform over the height of the building. It has to be noted that seismic isolation systems may not be effective on sites with soft soils or on structures with high fundamental period (tall building). The American architect, Frank Lloyd Wright, was the first person to implement some kind of base isolation technique in the Imperial Hotel structure at Tokyo. The first use of modern base isolated devices was in the Foothill Communities Law and Justice Center, near downtown Los Angeles. The 300-bed district hospital built in Bhuj during 2002 is the first in India to be installed with 280 lead-rubber and sliding bearings.

The various types of base isolation systems may be classified as (a) elastomeric bearings, (b) sliding bearings, (c) sliding/friction bearing, (d) rolling systems and (f) combined systems. Out of these systems, the elastomeric bearing is the most common type of base isolation device, and consist of alternating rubber and thin steel plates layers firmly bonded to each other.

The effective performance of these base isolators have been demonstrated during the 1994 Northridge earthquake, USA, the 1995 Kobe earthquake of Japan, the 2008 Sichuan earthquake of China, and the recent 2023 Turkey & Syria Earthquakes. It has to be noted that normal base isolation systems provide only



Normal base isolation systems provide only horizontal isolation and are rigid or semi-rigid in the vertical direction.



horizontal isolation and are rigid or semi-rigid in the vertical direction. Several codes have been developed for the specification and design of seismic isolation devices. The salient clauses in the recent Indian code, IS 1893-Part 6 (2022) on base isolated buildings have been indicated. It is seen that the use of these base isolators will be beneficial, in spite of their high initial cost, especially in critical infrastructure such as bridges and hospitals.

REFERENCES

1. AASHTO (2014) Guide Specification for Seismic Isolation Design, 4th Edition, Washington D.C. USA.
2. EN 15129:2018R Anti-seismic Devices, European Committee for Standardization, Brussels, 180 pp.
3. IS 1893-Part 6(2022) Criteria for Earthquake Resistant Design of Structures-Part 6 Base Isolated Buildings, Bureau of Indian Standards, Feb. 2022, 13 pp.
4. ISO 22762-1 (2018) Elastomeric Seismic-protection Isolators - Part 1: Test Methods, International Standards Organization. Geneva, Switzerland.
5. ISO 22762-3 (2010) Elastomeric seismic-protection isolators - Part 3: Applications for buildings - Specifications, International Standards Organization, Geneva, Switzerland.
6. ISO/TS 22762-4 (2014) Elastomeric seismic-protection isolators - Part 4: Guidance on the application of ISO 22762-3, International Standards Organization, Geneva, Switzerland.
7. Jangid, R.S. and Kelly, J. M. (2001) "Base Isolation for Near-fault Motions", *Earthquake Engineering & Structural Dynamics*, Vol. 30, 2001, pp. 691-707.
8. Kelly, J.M. (2012) *Earthquake-resistant Design with Rubber*, Second edition, Springer-Verlag, London, 2012, p. 243.
9. Kircher, C.A. (2012) "Chapter 12: Seismically Isolated Structures", in FEMA P-751, 2009 NEHRP Recommended Seismic Provisions: Design Examples, Federal Emergency Management Agency, Washington D.C., Sep 2012, p. 916.
10. Mayes, R.L., Brown, A.G., and Pietra, D. (2012) "Using Seismic Isolation and Energy Dissipation to Create Earthquake-resilient Buildings", Paper Number 093, NZSEE Conference www.nzsee.org.nz/db/2012/Paper093.pdf
11. Naeim, F., and Kelly, J.M. (1999) *Design of Seismic Isolated Structures; From Theory to Practice*, John Wiley, New York, p. 304.
12. Nishi, T., Kelly, J.M., and Zhou, F.L. (2009) "Rubber Structural Mounts Save Lives During Earthquakes", *ISO Focus*, June, pp. 26-28.
13. Skinner, R.I., Robinson, W.H., and McVerry, G.H. (1993) *An Introduction to Seismic Isolation*, John Wiley & Sons, New York, p. 376.
14. Sönmez E., Collins, R., and Zimmerman, R. (2023) "When the ground shook-Post-disaster observations of the Kahramanmaraş, Türkiye earthquake sequence-Part 1", *STRUCTURE Magazine*, ASCE, July 2023, pp.10-15.
15. Subramanian, N. (2016) *Design of Steel Structures*, 2nd Edition, Oxford University Press, New Delhi, p. 883.
16. Walters, M. (2015) "Seismic Isolation-The Gold Standard of Seismic Protection", *STRUCTURE Magazine*, ASCE, July, p. 11-14.
17. Zhou, F. and Xian, Q. (2001) "Recent Development on Seismic Isolation, Energy Dissipation, Passive and Semi-active Control of Structures in P.R. China", in *Earthquake Engineering Frontiers in the New Millennium*, B.F. Spencer and Y.S. Hu, (Editors) A.A. Balkema, Lisse, Netherlands, 2001, pp. 279-285.
18. <https://theconversation.com/buildings-left-standing-in-turkey-offer-design-guidance-for-future-earthquake-resilient-construction-202089>
19. <https://www.enr.com/articles/42366-the-10-largest-base-isolated-buildings-in-the-world>

ISOLATION BEARINGS FOR ARCH BRIDGE, MUMBAI COASTAL ROAD PROJECT



A. Santanu Majumdar
Mageba Bridge Products Pvt. Ltd.
Kolkata, India



B. Santanu Adhikary
Mageba Bridge Products Pvt. Ltd.
Kolkata, India

INTRODUCTION

The navigational span arch bridge of Mumbai Coastal Road Project (South), Package 2 consists of two steel arches, Left Hand Side (LHS) and Right Hand Side (RHS) arches, with largest length of 136 m. The arch bridges were designed with the assumption of using elastomeric bearings as the supports. Each arch is designed to be supported at 4 locations over elastomeric bearings. In most of the other spans of this project (both package 1 and package 2) considerably large elastomeric bearings (up to 1050 x 1050 x 298 mm) have been used, which might have prompted the designer to envisage elastomeric bearings for this span as well. The supports are required to be flexible supports so that the horizontal force transferred to the substructures are limited to certain values in different conditions. The challenge to provide the support system was not limited to addressing the gravity load

of about 33,000 kN in ultimate limit state and accommodating static displacements and rotations of the bridge supports, but extends to the dynamic behavior of the bridges during seismic actions.

STRUCTURAL AND FUNCTIONAL REQUIREMENT OF THE SUPPORT SYSTEM

STRUCTURAL REQUIREMENT

The project specification specified 8 numbers of bearings, 4 under each arch. Each bearing was to carry a ultimate vertical load of about 33,000 kN. A rotation of 0.01 radian was to be allowed on each bearing. A longitudinal movement of ± 209 mm (in extreme event) and transverse movement of ± 155 mm (in extreme event) were to be allowed.

FUNCTIONAL REQUIREMENT

The two arches were designed with flexible bearings at the supports to reduce the seismic



Fig. 1: Artist's impression of the Arch bridges



Fig. 2: Arch bridges, MCRP

horizontal forces to be transferred to the substructures. They were designed considering elastomeric bearings at the supports. According to the project requirement, the bearings system should provide the following functional solutions:

1. Providing adequate lateral flexibility under gravity load to achieve the reduced force response
2. The bearings should have the horizontal stiffness values as close as to the design values
3. To restore the structure back nearly to its original position after events like an earthquake

CHALLENGES

HIGH LOAD AND LIMITED SPACE

The main challenge was to provide an elastomeric bearing which will cater for such a huge gravity load and that should be accommodated in the limited space over the towers.

ALLOWING HIGH ROTATION

The next challenge was to provide an elastomeric bearings which would allow a rotation of about 0.01 radian. The plan dimensions of the elastomeric bearings was becoming high thereby increasing the rotational stiffness. To reduce the rotational stiffness, the height of the bearings was becoming prohibitively high.

MANUFACTURING AND QUALITY CONTROL OF ELASTOMERIC BEARINGS OF HUGE SIZE

The size of the elastomeric bearings designed for this huge load, displacements and rotation, was coming out to be prohibitively large to be feasible to be manufactured in controllable quality.

SOLUTIONS

INTRODUCTION OF ERADIQUAKE® ISOLATION BEARING SYSTEM

All possible solutions of modern base isolation techniques were evaluated to define the support system of the bridges and finally a specially designed EradiQuake® Bearing system was adopted. EradiQuake® is a custom designed isolation bearing composed of a Disc Bearing

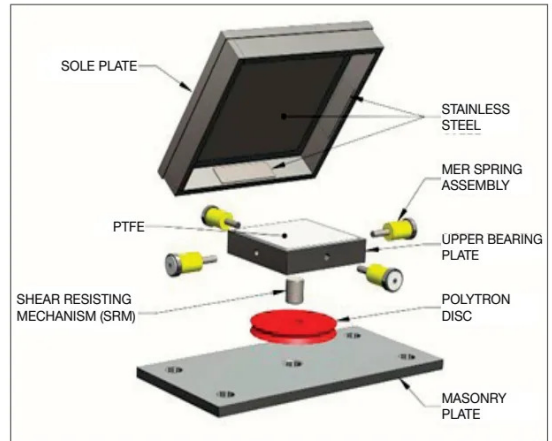

Fig. 3: Assembled Eradiquake® bearing



Fig. 4: Different parts of Eradiquake® bearing

and MER springs, which offers all the standard requirements of an Isolation system.

EradiQuake® System (EQS) is a state of the art Isolation Bearing System designed to minimize forces and displacements experienced by structures during an earthquake. This isolation bearing, originally developed by R.J.Watson Inc., USA, is also recognized in AASHTO Guide Specification for Isolation Design. In addition to providing isolation to the structure, the EQS transfers the energy of a moving mass (kinetic energy), such as a bridge superstructure during an earthquake, into heat and spring (potential) energy. This is done via:

- Friction between Teflon/stainless interface
- Compression of the MER

The Seismic Properties of the proposed Eradiquake® bearings are as follows:

| EQS | P,max (ULS) | Kd (kN/mm) | Kd (kN/mm) | disp (mm) | disp (mm) | disp (mm) | Keff (kN/mm) | EDC (kN-mm) |
|----------------|-------------|------------|------------|-------------|--------------|-----------|--------------|-------------|
| Model | (kN) | Long. | Trans | Long. (ULS) | Trans. (ULS) | Seismic | Seismic | Seismic |
| EQS23600 (LHS) | 33,128 | 12.9 | 12.9 | 209 | 111 | 105 | 14.95 | 99,200 |
| EQS17900 (RHS) | 25,121 | 9.2 | 9.2 | 207 | 188 | 105 | 11.76 | 112,800 |

| | |
|--------------------|--|
| P,max (ULS) | Maximum vertical load per bearing in ultimate limit state |
| Kd | Post Elastic Stiffness, Spring Rate |
| disp | Displacement Across Isolation Bearing |
| Keff | Declared effective stiffness at seismic displacement |
| EDC | Declared Energy Dissipated per Cycle at seismic displacement |

PROVIDING FLEXIBLE SUPPORT TO THE STRUCTURE WITHIN THE LIMITED SPACE

The introduction of Eradiquake® bearings achieved the purpose of providing flexible support below the arches. The desired horizontal flexibility could be achieved by the MER springs. The dimension of the bearings could be kept within the limited space with the help of Polyurethane disc which has much higher load capacity.

ADEQUATE ROTATIONAL CAPACITY

The optimum rotational stiffness of the Polyurethane rotational disc provided the desired rotational capacity of the bearings.

DISSIPATION OF ENERGY DURING SEISMIC EVENT

The added achievement was the transfer of seismic energy by frictional dissipation between Teflon / stainless interface and spring (potential) energy by compression of MER springs which would reduce the actual movement of the structure during seismic event.

RESTORING THE STRUCTURE AFTER SEISMIC EVENT

The restoration of structure to its nearly initial position could be achieved by the release of spring (potential) energy of the MER springs in both longitudinal and transverse directions.



Fig. 5: MER springs in compressed position

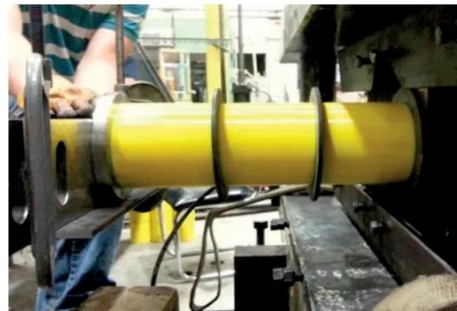

Fig. 6: MER springs in relaxed position

ADDITIONAL FEATURES

The bearings have been equipped with following additional features for enhanced life and performance:

- ROBO@SLIDE has been used as the sliding material. This is a special sliding material made of modified, ultra-high molecular polyethylene

with reduced abrasion resistance and increased bearing capacity. It ensures high durability and service life contributing in low life cycle cost.

- No material prone to ageing has been used ensuring high durability/ service life contributing in low life cycle cost. The Polyether urethane rotational disc has excellent weathering properties when subjected to prolong exposure to seawater, fresh water, ozone and other deleterious chemicals.
- The urethane disc remains flexible within a wide range of temperature (-70°C to 121°C). Therefore, under normal atmospheric conditions there is no problem with the rotational element softening or crystallizing during temperature extremes.
- Simple and same connection detail for all bearing providing ease of installation.

ADVANTAGES OF ERADIQUAKE® BEARINGS

Some of the advantages of Eradiquake® isolation bearings over the other isolation bearings are mentioned below:

- A completely secured and fail-safe system compared to elastomeric isolators for high load application as there will be no reduction of loaded area due to horizontal displacement.
- Can be designed for different stiffness in longitudinal and transverse directions which gives higher design and optimization flexibility. This is not possible with Elastomeric Isolators or Friction Pendulum.
- Much higher life expectancy as there is no material prone to ageing.
- Unlike Friction Pendulum Bearings, there is no vertical displacement due to horizontal movement.

TESTING ON BEARINGS

The following tests were conducted on the actual bearings to evaluate the designed behavior of the bearings:

- Proof Load Test (AASHTO GSFSID 17.2.1)
- Combined Compression and Shear Test (AASHTO GSFSID 17.2.2).



Fig. 7: Bearing testing in Dynamic Testing Machine



Fig. 8: Bearing testing



Fig. 9: Bearing testing

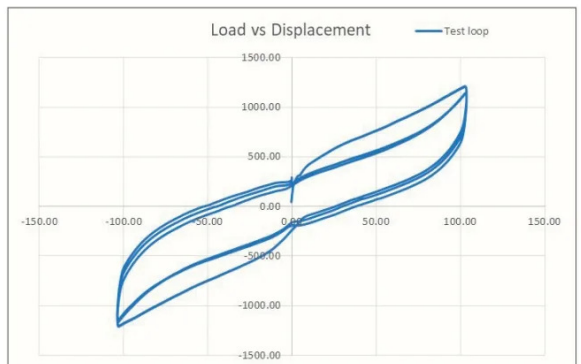

Fig. 10: Force-displacement diagram of EQS17900 (RHS) - test for seismic movement

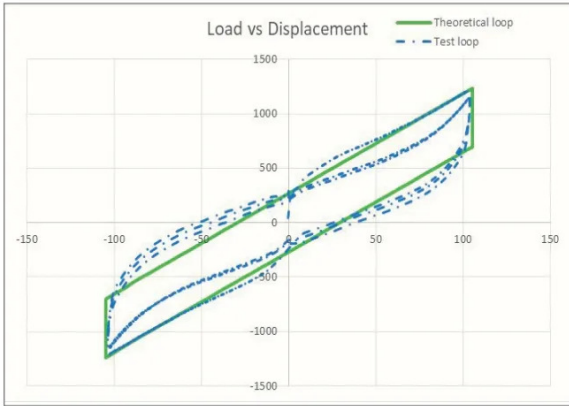

Fig. 11: Force-displacement diagram of EQS17900 (RHS) – comparison with theoretical loop



Fig. 12: Force-displacement diagram of EQS23600 (LHS) – test for seismic movement



Fig. 13: Force-displacement diagram of EQS23600 (LHS) – comparison with theoretical loop

The comparison of test properties with respect to the design properties are shown in the table below:

| Table 2 | | | | |
|----------------|----------------------|---------------------|--------------------|-------------------|
| Bearing | Keff, design (kN/mm) | EDC, design (kN-mm) | Keff, test (kN/mm) | EDC, test (kN-mm) |
| EQS17900 (RHS) | 11.76 | 112,800 | 11.41 | 107,960 |
| EQS23600 (LHS) | 14.95 | 99,200 | 12.72 | 98,870 |

INSTALLATION

The bearings were supplied with bottom anchor plates with shear studs welded on the bottom anchor plates. The bottom anchor plates were installed over the pedestal and the pedestals were cast. The main bearings were placed over the already installed anchor plates. The bolts were then fastened with the threaded holes present in the anchor plates.



Fig. 14: Installed bearings

CONCLUSION

Specially designed EradiQuake® Isolation bearings used in this project are not only the larger of their kind but also are equipped with many unique features required to meet the unprecedented structural demands. This system not only provided the requisite isolation to the arch bridges by reducing seismic lateral force to the desired level and dissipating seismic energy, but is also well equipped to give requisite degrees of freedom including high rotation demand. The bearing system also addressed the limitation of space issue. Hence, it can be concluded that the specially designed Eradiquake® seismic isolation system provided to this project meet all the complex demands of this special structure.

Due to the isolation requirements, it was necessary to incorporate large modular expansion joints capable of accommodating substantial movement in both the longitudinal and transverse directions. This requirement has been effectively met by implementing mageba TENSA®MODULAR joints.



Fig. 15: Reference pictures

REFERENCES

1. AASHTO 2010 Guide Specifications for Seismic Isolation Design
2. Eradiquake® Product Brochure, RJ Watson INC.



NATIONAL TRAINING PROGRAMME ON

URBAN RISK MITIGATION - FOCUS ON SEISMIC SAFETY OF STRUCTURES ORGANIZED

(To promote National Earthquake Risk Mitigation Project (NERMP) under 15th Finance Commission)

13 - 15 MARCH 2024
NIDM CAMPUS, DELHI

Organized by
National Institute of Disaster Management
Ministry of Home Affairs, Govt. of India

In collaboration with
Bureau of Indian Standards
Building Material & Technology Promotion Council
Delhi Disaster Management Authority and
Seismic Academy (An initiative of HILTI India Pvt.Ltd.)

 /NIDMHAINDIA
  /NIDMHAINDIA
  /NIDMHAINDIA
  /NIDMINDIA
  /NIDMHAINDIA

To know more, visit - <https://theseismicacademy.com/workshop-detail/national-training-program-on-urban-risk-mitigation-focus-on-seismic-safety-of-structures>

EMERGING TECHNOLOGIES FOR EARTHQUAKE RESILIENCE

Gain insights into base isolators and seismic dampers

• LIVE
Webinar

📅 **Date: 14th June 2024, Friday**
🕒 **Time: 3:00 PM - 4:30 PM**

 SEISMIC
ACADEMY



SPEAKER

Dr. Vasant Matsagar
Professor, Dogra Chair and
Head, Department of Civil
Engineering, IIT Delhi



SPEAKER

Dr. Yogendra Singh
Professor, Department of
Earthquake Engineering,
IIT Roorkee



MODERATOR

Shounak Mitra
Head, Codes & Approval
Hilti India

REGISTER NOW ➤

<https://theseismicacademy.com/webinar-detail/emerging-technologies-for-earthquake-resilience>

WEBINAR ON EMERGING TECHNOLOGIES ON EARTHQUAKE RESILIENCE

Growing concerns about seismic events in our country has enforced structural engineers and architects to embrace the hazardous effect of ground motion in design. Over a period, extensive research work on the topic and subsequent evolution of Indian Standards have led to a lot of sensitization on the topic among different stakeholders in the construction fraternity. With increase in the seismic activities across the country, it is important to adopt proactive mitigation measures to minimize the loss of life and damage to assets caused by it. Developing and implementing high-level seismic design strategies is a significant step in this regard. In the last decades, countries with advanced seismic protection technologies have significantly reduced losses due to seismic damage in structures through developing and implementing such strategies, including seismic isolation and vibration control (dampers) designs. Adoption of these technologies ensure the continuous operation of the structure even in the aftermath of a strong seismic event. And to effectively understand, adopt and implement them, it is important to impart the right knowhow on this topic.

With this endeavor, Seismic Academy, an initiative by Hilti, organized a webinar on “Emerging Technologies on Earthquake Resilience” on 14th June 2024. Dr. Vasant Matsagar, Head, Department of Civil Engineering, Indian Institute of Technology (IIT) Delhi and Dr. Yogendra Singh, Professor, Department of Earthquake Engineering, Indian Institute of Technology (IIT) Roorkee shared their expertise with the participants on the use of base isolation and seismic dampers respectively, for seismic resilient structures.

Shounak Mitra, Head – Codes & Approval, Hilti India Pvt. Ltd. and the moderator for the session, set a context by introducing Seismic Academy and the different initiatives under its aegis to the participants.

Dr. Vasant Matsagar started with the overview of the agenda wherein he looked to give some tenets of base isolation system and how it is being implemented, particularly in the Indian context and what has been the latest developments. He looked to outline his lecture around the need for base isolation, how code developments have happened over the years both in India as well as worldwide, specific examples of structure where these are implemented and the way forward.

There are enough reference material on the subject and the encouragement to participants is to appropriately refer to them. A very comprehensive book on “Passive Vibration Control of Structures” by Suhasini Madhekar and Vasant Matsagar is also available for the construction professions.

Dr. Matsagar started with the different types of structural vibration control devices which can be categorized as passive, semi-active, active and hybrid systems and the focus for the session was to deliberate on the base isolation which is a type of passive control devices. A base isolation, by definition, is used to render flexibility to the structure which in turn enhances its time period, thereby allowing more displacements. With the incorporation of base isolation system below the structure, the structure is isolated from the shaking ground and resonance is conveniently avoided. In addition, there is significant amount of energy dissipation which happens through damping. As a result, there is significant amount of reduction in the response of the superstructure in terms of acceleration. As compared to conventional structures which require strengthening against earthquake, this can completely be avoided for base isolated structures.

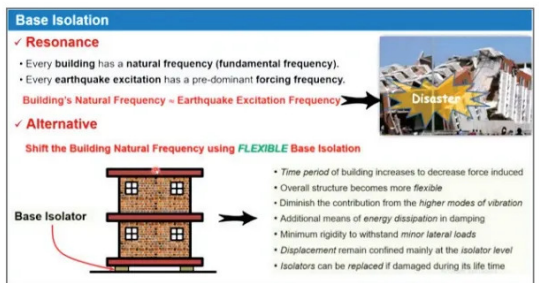
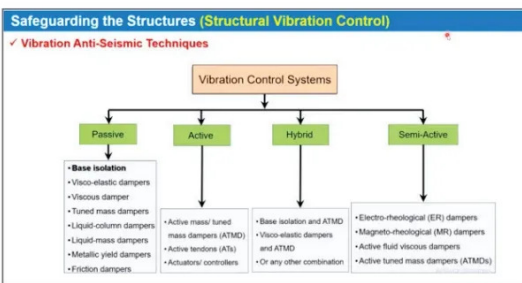

He explained the behavior in further detail through the response spectrum analysis and emphasized that a significant reduction to the tune of 50% in spectral acceleration can be achieved through base isolation and in such cases, the design will be governed more by other load combinations rather than earthquake. However, he also mentioned that enhanced flexibility brings with it increased displacement. To control the excessive displacement, dampers are provided. As compared to conventional structures, the damping in base isolated structures can be as high as 10-15% depending on the material being used. This synergy enables us to control the acceleration response on one hand and the displacement of the structure on the other hand.

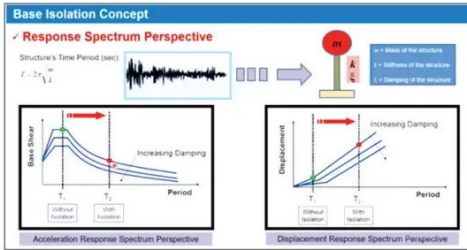

Dr. Matsagar briefly introduced to the different types of base isolators which are commonly in practice in the industry and their common areas of application. While every type of isolator has its own advantages, a base isolated structure is generally provided with more than one type of isolation system which helps to overall economize the application cost.

He highlighted on the different research work which is being carried out at IIT Delhi on this subject. One such innovation is the development of patented isolation technique through which it would be possible to control multi directional earthquake excitation in horizontal plane by using different kind of restoring springs. This technology is now being used for certain industrial equipment and finds use in case of lightweight structures. The same has been investigated through a shake table test and it has been observed that the floor acceleration could be reduced by as high as 35% as compared to a fixed-base structure.

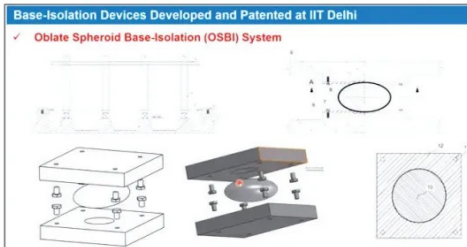
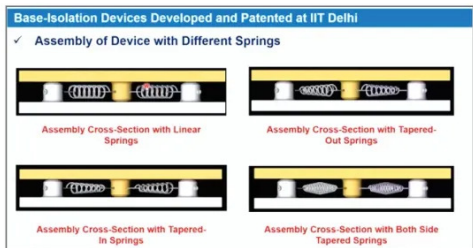

Dr. Matsagar added that because of the introduction of the isolation system at the base, significant amount of stress is reduced in the super structure in both the directions.

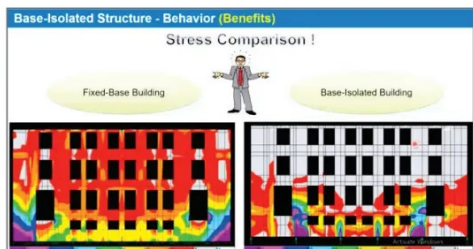
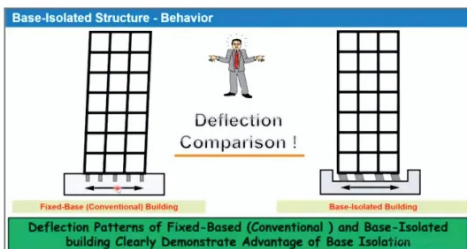

He touch based upon the different seismic zones of the country as per IS 1893 and emphasized that in higher seismic zones, lifeline structures like healthcare facilities need to be functional during as well as after an earthquake and base isolation provides an excellent alternative for the purpose over conventional approaches. Reference was also made to the proposed revision of IS 1893.

Earlier, international standards were commonly referred to in this regard. However, Bureau of Indian Standards (BIS) under the Civil Engineering Committee (CED) 39 has formulated IS 1893 part 6 in 2022 which gives clear guidelines on Base Isolated Buildings under Criteria for Earthquake Resistant Design of Structures.

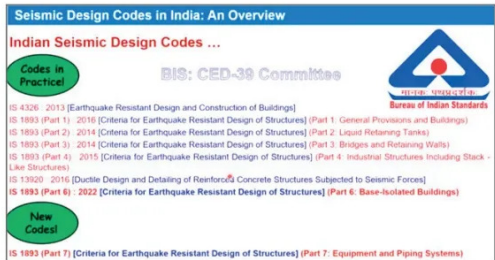
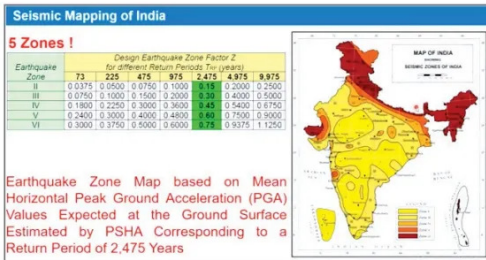

The code typically talks about different approaches for analysis and design of base isolated structures, and they are divided into dynamic analysis (response spectrum analysis and time history analysis) and equivalent lateral force analysis. For all seismic designs, however, it is important to perform a static analysis to establish a minimum level of design displacement and forces.

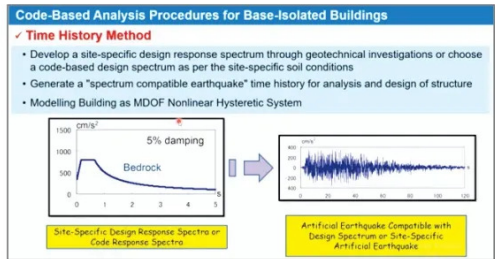
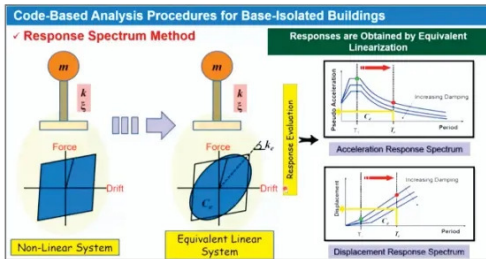

It is very important to address the fact that what are the appropriate locations for providing the base isolation systems in a structure and the Indian Standard does cover this aspect in detail. There are different alternatives as to where they should be provided – in the sub-basement, at the top of the basement columns, at the bottom of the ground floor columns or even in the superstructure. All these locations have their advantages and disadvantages, and the selection is done based on the engineering judgement of the structural engineer. However, a gap has to be essentially maintained from the adjacent structure to ensure effective isolation. Even the choice of the system is an important factor governing the overall performance.

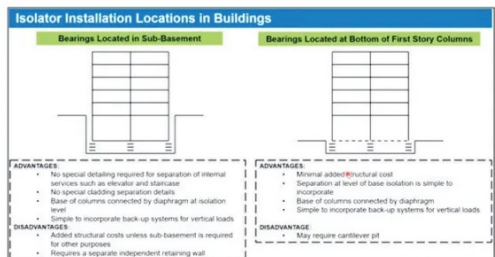
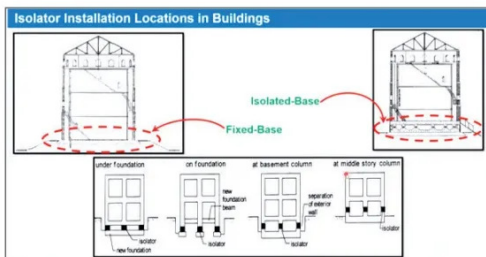

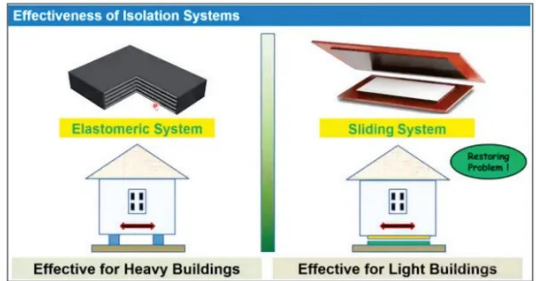
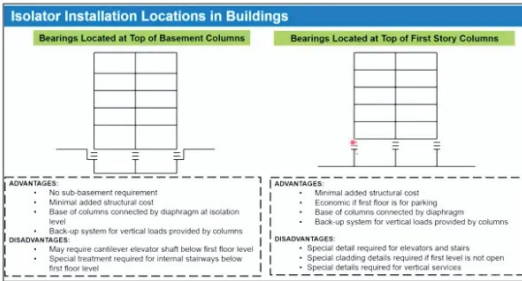

The technology can in fact be extended to the retrofitting of existing structures. However, overall, the application of base isolated structures in India is still limited as compared to other seismically active countries over the globe. He shared some case studies of base isolated structures in India which have been already executed.



Dr. Matsagar in his concluding remarks also addressed the apprehension of different stakeholders about the enhanced expenses which might be incurred due to implementation of base isolation system within a building. A comparative analysis carried out to indicate a difference of around 6 to 7 percent in the overall cost as compared to conventional structures. At the same time, his recommendation was that if the isolated systems can be indigenously made, the cost can be further optimized.

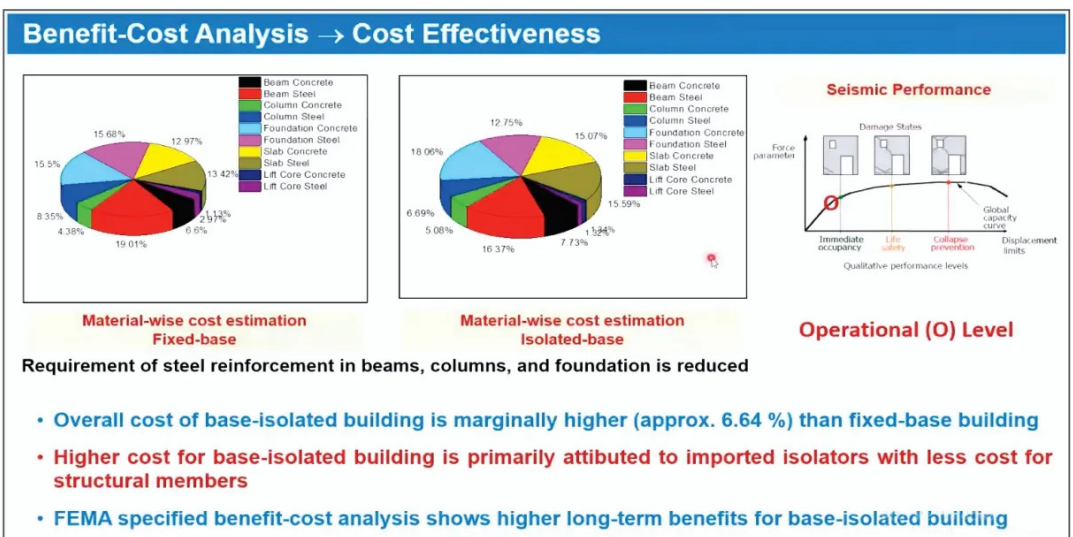

Dr. Yogendra Singh in his deliberation focused on the use of seismic dampers in structures. He mentioned that irrespective of the type of seismic performance enhancement measures being adopted, one has to take into consideration the characteristics of ground motion. The acceleration causes an inertia force which causes damage to the structure. The force also depends on the natural time period of the structure and through base isolation, this is adjusted to minimize the effect of earthquake on a structure. There can also be another dimension to this analysis. The acceleration due to earthquake changes its direction very rapidly which imparts an energy to the structure. The structure needs to dissipate this energy at the same rate at which it is received. This dissipation can happen only through damage. While base isolation detunes the structure, thereby reducing the energy imparted to it and as a result causing lesser damage, another way of enhancing the performance is to provide supplemental devices to dissipate the energy. This means that the structure as a whole will be required to dissipate lesser energy, resulting in lesser damage to the structure.

INDIAN INSTITUTE OF TECHNOLOGY ROORKEE

SEISMIC DESIGN WITH DAMPERS

Yogendra Singh
 Professor, Railway Bridge Chair
 Department of Earthquake Engineering
 Indian Institute of Technology Roorkee
 Roorkee, India

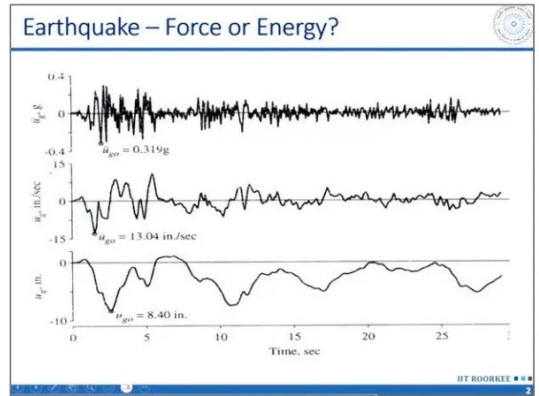
In case of supplemental energy dissipation, it is acting like an added damping and hence at any given period, with increase in damping, the response spectrum and therefore the forces on the structure will reduce. Similar effect can be observed on the displacement as well. Consequently, the inter storey drift also reduces.

Acceleration at the different floor levels are also reduced and this has significant impact on the behavior non-structural components. Non-structural components are of two types – acceleration sensitive e.g., equipment capped at the floor and displacement sensitive which depend on the drift. Thus they are adequately safeguarded in the event of an earthquake by the provision of dampers.

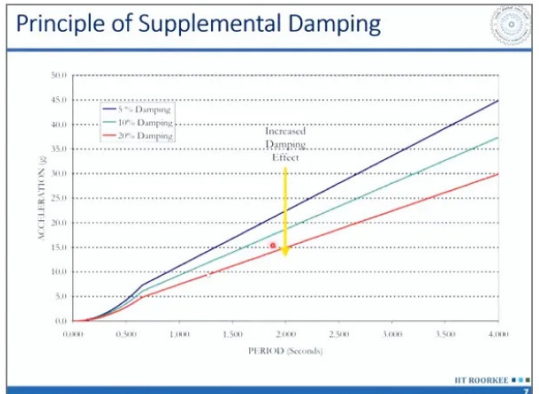
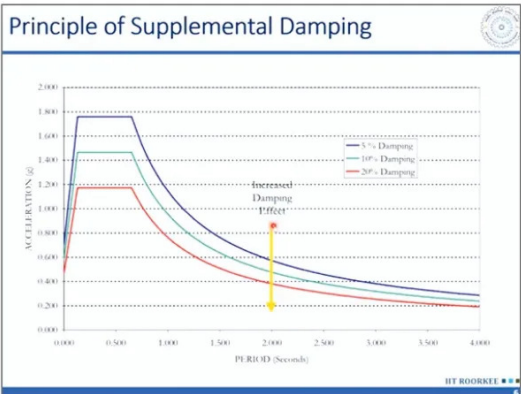

Commonly used dampers are passive dampers and tuned systems. In passive system, the energy is dissipated through friction, yielding or viscosity of the material. Passive dampers can be classified based on the energy dissipation mechanism i.e., either through displacement or through velocity. Displacement dependent devices can be friction dampers or metallic dampers, while velocity dependent devices can be fluid viscous dampers or viscoelastic dampers. Tuned systems can be tuned mass dampers or tuned liquid dampers.

Dr. Singh further elaborated on each type of damper with their individual working principle.

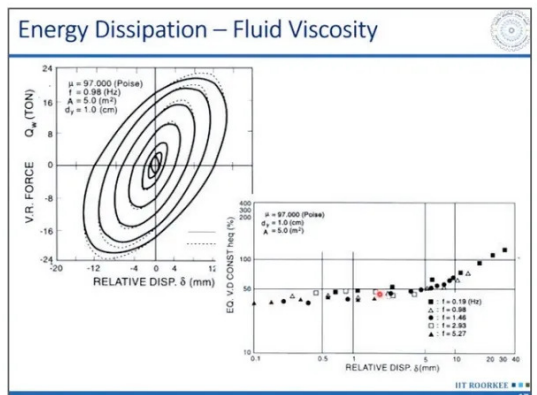
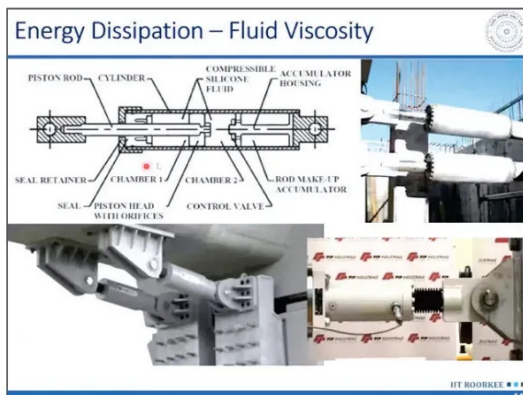
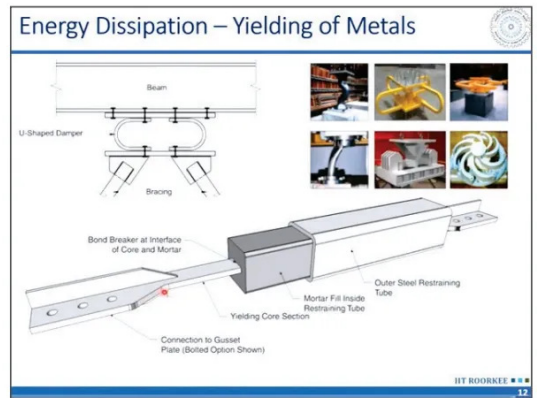
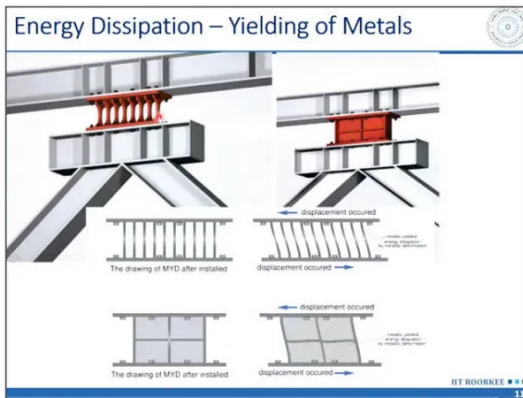
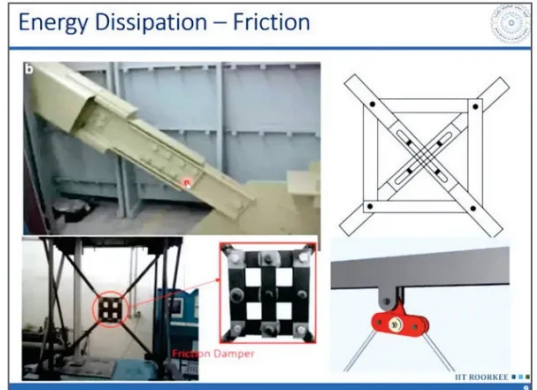
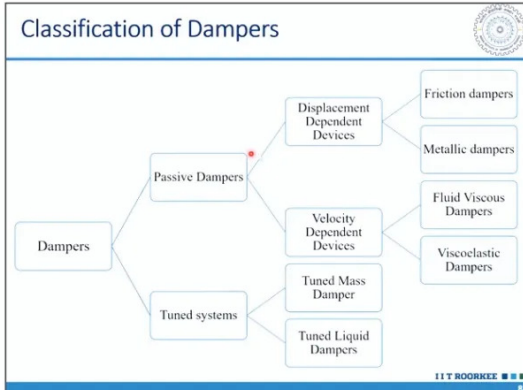

In absence of national standard on seismic dampers, ASCE-7 and ASCE-41 provide detailed guideline for the design of damping devices. He emphasized here that the use of these technologies is not intended towards economizing the overall cost of execution of the structure but to achieve enhanced performance in the event of earthquake. Specifically for lifeline structures like hospitals which require to be operational throughout, these devices provide the best design option.

The fundamental design philosophy is that during design basis earthquake (DBE), the structure should remain elastic and under maximum considered earthquake (MCE), there should be limited yielding so that there is no visible damage, and it continues to perform even under MCE. There are certain considerations and restrictions in terms of considering the seismic base shear, which need to be strictly adhered to.

Seismic Force-Resisting System

The seismic base shear used for design of the seismic force-resisting system shall not be taken as less than 1.0V if either of the following conditions apply:

1. **In the direction of interest, the damping system has fewer than two damping devices on each floor level, configured to resist torsion.**
2. **The seismic force-resisting system has horizontal irregularity or vertical irregularity.**

IIT ROORKEE ■■■ 20

Damping System

Damping devices and all other components required to connect damping devices to the other elements of the structure **shall be designed to remain elastic for MCE loads.**

Force-controlled elements of the damping system shall be designed for seismic forces that are **increased by 20%** from those corresponding to average MCE response.

IIT ROORKEE ■■■ 21

When the devices are designed to remain elastic under MCE loads, one must consider the low cycle and large displacement degradation caused by seismic loads, high cycle and small displacement degradation caused by thermal, wind and other cyclic loads as well as forces and displacements caused by gravity loads. A common apprehension with friction based devices is that with time these may get corroded or be subject to abrasion over period of time. As a result, there can be adhesion between the metal elements and the devices may not effectively function in the event of an earthquake. So, the device should be adequately designed and protected against corrosion. In addition, the effect of other factors temperature, humidity, moisture, radiation, etc. should also be taken into consideration.

Additionally, if four or less energy dissipation devices are provided in any storey of a building in either principal direction or less than two devices are located on each side of the center of stiffness of any storey in either principal direction, all the devices should be designed to sustain displacement equal to 1.3 times the maximum calculated displacement under MCE. A velocity-dependent device should be capable of sustaining force and displacement associated with a velocity equal to 1.3 times the maximum calculated velocity under MCE.

Dr. Singh summarized his session with a case study on the use of seismic dampers in a typical building.

The deliberations were followed by Q&A and ended with a vote of thanks.

BREATHING LIFE INTO EXISTING STRUCTURE - ENHANCING SAFETY OF A CHEMICAL PLANT



Aishwarya Gupta
Sr. Project Engineer
NVLN Constructions Pvt. Ltd.

INTRODUCTION

Chemical plants are complex facilities with significant structural demands. Over time, various factors such as corrosion, weather-related deterioration and heavy machinery usage contribute to structural distress. This study focuses on a single storied chemical plant, heavily affected by persistent corrosion and leakages, leading to concrete cracking and spalling. The aim was to evaluate the structural integrity using NDT methods, followed by targeted strengthening to enhance the building's safety and serviceability.

BACKGROUND

The chemical plant in question exhibited multiple distress signals, including exposed corroded reinforcement, dampness, leaching, spalling, and cracks in concrete surfaces. These deteriorations posed significant risks to the structural stability, necessitating a thorough investigation and rehabilitation strategy.



Fig. 1: Distress in structural element

DETAILED STRUCTURAL ANALYSIS AND STRENGTHENING SOLUTIONS

STRUCTURAL ANALYSIS

1. Initial Assessment:

- **Visual Inspection:** A thorough visual inspection was conducted to identify visible signs of distress such as cracks, spalling, and exposed reinforcement. This preliminary assessment provided a broad understanding of the extent of damage and helped pinpoint areas needing detailed investigation.
- **Load Assessment:** Considering the industrial nature of the building, the loads acting on the structure were calculated. This included dead loads from the building materials and live loads from the machinery and operational activities. Special attention was given to take into consideration the impact of equipment vibrations.

2. Non-Destructive Testing (NDT):

- **Ultrasonic Pulse Velocity (UPV) Test:** This test helped assess the quality and uniformity of the concrete. The results indicated significant variations, with many areas falling into the 'poor' and 'doubtful' categories, suggesting internal flaws and voids.
- **Rebound Hammer Test:** This test measured the surface hardness of concrete and provided an estimation of the compressive strength. Results consistently showed values below the acceptable threshold, indicating weakened concrete.
- **Core Strength Test:** Core samples were extracted and tested for compressive strength. The average strength was found to be below 15 MPa, significantly lower than the design requirements.
- **Cover Meter Study:** This test determined the depth of concrete cover over the reinforcement bars, which is

crucial for protecting against corrosion. Inadequate cover was noted in several areas.

- **Carbonation and Half-Cell Potential Difference Tests:** These tests identified the depth of carbonation and the corrosion potential of reinforcement bars. High levels of carbonation and severe corrosion were detected.
- **Chloride Measurement Test:** Elevated chloride ion concentrations were found, which exacerbate corrosion of reinforcement bars.

STRENGTHENING SOLUTIONS

CONCRETE JACKETING FOR BEAMS AND COLUMNS

Concrete jacketing was identified as a primary strengthening technique for both beams and columns. The process began with unloading the existing structural elements as much as possible by using temporary supports like shoring and jacks. This was critical to reduce the stress on the beams and columns during the strengthening process.

For beams, the first step involved meticulous surface preparation, which entailed roughening the surface to remove contaminants such as grease, oil, and external dust particles. This preparation was crucial to improve the bond between the old and new concrete. Once the surface was adequately prepared, longitudinal and transverse reinforcement bars were added around the existing beams, with the longitudinal bars running parallel to the beam's

length and the transverse bars positioned perpendicularly.

The beams were then encased on three sides with a 75 mm thick layer of reinforced concrete, forming a protective jacket that significantly enhanced the load-bearing capacity. Formwork was carefully installed to shape this new encasement, ensuring precision in the dimensions and contours. Following the setup of formwork, micro-concrete, known for its high strength and non-shrink properties, was poured to form the new jacket.

To ensure the new and existing concrete sections functioned as a composite whole and to prevent delamination under load, stirrups were placed in drilled holes, and dowels with adhesive anchors were installed, effectively interconnecting the two layers of concrete. Specific reinforcement details were meticulously followed: 16 mm diameter bars were provided as main bars, with 7 bars in total, essential for bearing tensile loads. Additionally, 8 mm diameter bars were used as shear keys with spacing of 150 mm center-to-center (c/c), which helped resist shear forces, and 8 mm diameter ties were also provided at 150 mm c/c spacing to maintain the shape and integrity of the concrete encasement. This comprehensive process ensured the beams were significantly strengthened and made more durable, capable of bearing increased loads and having an extended service life.

For the columns, a similar approach was taken with some key differences. First, the load on the existing columns was reduced by temporarily supporting the structure. Then, the column surfaces were roughened, cleaned, and a bonding agent was applied for good adhesion. The columns were encased with a 100 mm thick layer of reinforced concrete.

For longitudinal reinforcement, six 20 mm diameter bars were used, crucial for carrying the axial load and ensuring structural integrity. Transverse reinforcement involved 8 mm diameter bars, serving as shear keys and ties, spaced at 150 mm center-to-center. These bars resist shear forces and prevent diagonal cracking and buckling.

“

This comprehensive process ensured the beams were significantly strengthened and made more durable, capable of bearing increased loads and having an extended service life.

”

A clear cover of 40 mm was maintained to protect the reinforcement from environmental effects and ensure durability. Finally, non-shrink cementitious micro-concrete was used for encasing, chosen for its low shrinkage properties to minimize thermal cracking. This combination of materials and reinforcement ensures the strengthened columns can effectively support the structure while maintaining durability and safety.

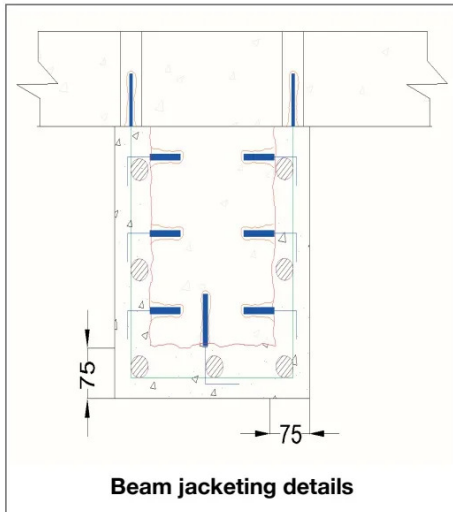

Beam jacking details

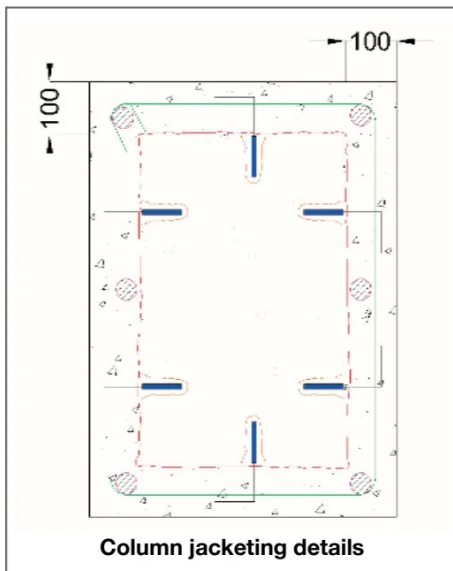

Column jacking details

Fig. 2: Column & Beam Jacketing Details

SLAB STRENGTHENING

The slabs in the chemical plant were strengthened by adding additional steel reinforcement and laying welded wire fabric to reduce shrinkage cracks. This process began with a detailed assessment of the existing slab conditions, followed by the placement of the new reinforcement. Shotcreting, a method of spraying concrete onto a surface, was used to increase the slab thickness. This technique provided an additional layer of concrete, enhancing the load-carrying capacity of the slabs. The new concrete was carefully applied to ensure a uniform and consistent layer, avoiding any voids or weak spots.

EPOXY INJECTION GROUTING

For addressing cracks in various structural elements, low-viscous epoxy injection grouting was employed. This method involved injecting epoxy resin into cracks and microfissures in the concrete using non-returnable packers. The epoxy resin filled the cracks and voids, restoring the integrity and strength of the affected areas. The process was carefully controlled to ensure even distribution of the resin, which was critical for achieving a durable repair. The use of non-returnable packers helped ensure that the epoxy resin penetrated deep into the cracks and did not backflow, providing a long-lasting solution to the problem of cracks and fissures.

CORROSION PROTECTION

Given the severe corrosion observed in the reinforcement bars, anti-corrosive treatments were essential. The existing corroded reinforcement bars were treated with an anti-corrosive zinc-rich primer. This primer created a protective barrier on the steel surface, preventing further corrosion and extending the life of the reinforcement. Additionally, an anti-carbonation coating was applied to the entire structure. This coating was designed to prevent future carbonation, which could lead to further corrosion of the reinforcement bars and weakening of the concrete. By blocking the ingress of carbon dioxide and other corrosive elements, the anti-carbonation coating helped enhance the durability and serviceability of the structure.



Fig. 3: Concrete Jacketing of Column

IMPLEMENTATION AND QUALITY CONTROL

IMPLEMENTATION

The implementation of the strengthening process in the chemical plant was a meticulously planned and executed operation. It began with comprehensive site preparation, which involved clearing any debris, ensuring that the area was safe for workers, and setting up necessary equipment. Temporary structures, such as scaffolding and shoring, were erected to support the building loads during the strengthening process. This step was crucial to ensure the safety of the workers and the stability of the structure during the intervention.

One of the primary tasks in the implementation phase was the surface preparation of the existing concrete elements. This involved roughening and cleaning the surfaces to remove any contaminants such as grease, oil, and dust, which could impede the bonding of new concrete to the old. A bonding agent was applied to enhance the adhesion between the old and new materials, ensuring a strong and durable bond.

The next step was the installation of formwork, which was essential for shaping the new

concrete and holding it in place until it cured. The formwork had to be precisely designed and constructed to match the specifications of the strengthening plan. For beams and columns, the formwork was installed to encase the elements in a new layer of reinforced concrete, typically 75 mm thick for beams and 100 mm thick for columns.

The placement of additional reinforcement was another critical task. Steel reinforcement bars and welded wire fabric were added to the existing structural elements to enhance their load-carrying capacity. This reinforcement was carefully positioned according to the structural analysis, ensuring optimal strength and stability.

Once the formwork and reinforcement were in place, the concrete pouring process began. For beam and column jacketing, non-shrink cementitious micro-concrete was used. This type of concrete was chosen for its low shrinkage properties and ability to minimize the generation of heat during hydration, reducing the risk of thermal cracking. The concrete was carefully mixed and poured to ensure uniformity and consistency, avoiding any air pockets or voids that could compromise the structural integrity.

QUALITY CONTROL

Quality control was an integral part of the strengthening process, ensuring that all activities were carried out according to the highest standards and specifications. The quality control process began with the selection of materials. Only high-quality, technically approved materials, such as micro-concrete and epoxy resins, were used to ensure durability and effectiveness.

Throughout the strengthening activities, continuous monitoring and inspection were conducted to ensure adherence to the design specifications. This included regular checks on the preparation and installation of formwork, the placement of reinforcement, and the mixing and pouring of concrete. Any deviations from the plan were promptly corrected to maintain the integrity of the structure.

Special attention was given to the epoxy injection grouting process, used to fill cracks and voids in the concrete. The injection process was carefully controlled to ensure even distribution of the epoxy resin, which was critical for restoring the structural integrity of the affected elements. The use of non-returnable packers helped in achieving precise injection and preventing backflow of the resin.

After the completion of the strengthening work, post-retrofit testing was conducted to verify the effectiveness of the interventions. This included repeat NDT methods such as ultrasonic pulse velocity tests, rebound hammer tests, and core strength tests to assess the quality and strength of the retrofitted elements. The results of these tests confirmed that the structural integrity had been significantly enhanced, meeting or exceeding the required standards.

In addition to technical inspections, the strengthening process also included rigorous documentation. Detailed records of all materials used, procedures followed, and tests conducted were maintained. This documentation served as a valuable reference for future maintenance

and inspections, ensuring ongoing safety and performance of the chemical plant.

Overall, the meticulous implementation and stringent quality control measures ensured that the strengthening project was successfully executed, restoring the structural integrity and safety of the chemical plant. The combination of careful planning, high-quality materials, precise execution, and thorough testing provided a comprehensive solution to the structural challenges faced by the facility, ensuring its continued safe operation and longevity.

CONCLUSION

This case study underscores the critical importance of regular structural assessments and timely interventions in maintaining the safety and functionality of industrial facilities. The combination of thorough NDT, detailed structural analysis, and carefully executed strengthening measures successfully rehabilitated the chemical plant, ensuring its continued safe operation. The methodologies and techniques outlined provide a valuable reference for similar projects, highlighting best practices in structural strengthening.



WEBINAR ON - EARTHQUAKE-RESISTANT STEEL BUILDING DESIGNS

EXPLORE EARTHQUAKE - RESISTANT STEEL BUILDING DESIGNS

ABOUT THIS EVENT: Steel buildings and structures are rapidly gaining prominence in our country, particularly in various infrastructure segments. Even rooftop structures in existing buildings often utilize structural steel components. With the increasing frequency of earthquake tremors, understanding how to design these structures to be earthquake-resilient is paramount. Equally important is comprehending the behavior of connections in existing structures during earthquakes and addressing any issues that may arise.

To watch the recording, visit - <https://www.youtube.com/watch?v=GnzmpM1jtXc>

To know more, visit - <https://theseismicacademy.com/webinar-detail/lets-explore-earthquake-resistant-steel-building-designs>

THE TORRE MAYOR

A Pinnacle of Seismic Engineering in Mexico City



Completed in 2003, this 55-story skyscraper not only dominates the skyline but also represents the forefront of earthquake-resistant design. Built to last 2,500 years!

The City of Mexico City is growing vertically with skyscrapers dominating the skyline and Torre Mayor, a pinnacle of earthquake engineering, stands at its middle, soaring at a height of 225 meters as one of Latin America's tallest building.

The design and construction challenges that the City of Mexico presents are multi-faceted due to its location in one of the most adverse geologic and tectonic environments in the world. In 1985 a devastating earthquake claimed over 9,000 lives, despite its epicenter being almost 400 kilometers away from the city. Apparently, the subsurface below the center of this city of millions amplifies earthquakes.

As per Leobardo Dominguez, *"Mexico City is built on a lakebed, there are strata of soft clay going down 30 meters. When the seismic waves reach this sediment and are transferred to the surface, the whole layer begins to rock. It's a dynamic effect that amplifies earthquakes."*

Trumping nature with advanced technologies, Torre Mayor stands tall as a testimony to fine engineering and a landmark building resilient to earthquakes. The architecture of the building was done by Adamson Associates Architects, Zeidler Roberts Partnership, IDEA Asociados de los and Estados Unidos Mexicanos. WSP Group was entrusted with the structural engineering.



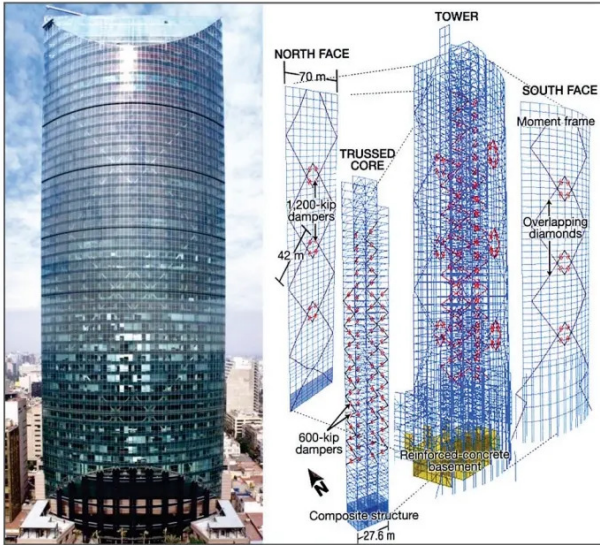

Building details

Designed as an office space, Torre Mayor is a 55 storied building, covering a total area of 84,000 sq.m. With contemporary architecture, the tower has 30,000 sq.m. of glass on the south facade with thermal and acoustic insulation. It was constructed in a span of 4 years and is known to be the only skyscraper in the world that has not had any major accidents or deaths during construction. The tower is occupied by more than 8,000 people.

Four underground and nine above-ground parking levels accommodate about 2000 cars. The building consists of 43

typical column-free office floors, with floor plates ranging from 1700 sq.m. to 1800 sq.m. The building has an 80 m X 80 m footprint at below grade levels, which is reduced to an 80 m X 65 m footprint from the 4th to the 10th level. Above the 10th level, the footprint is further reduced to its typical tower size of 48 m X 36, where a geometrical combination of a rectangle merged with an arch segment at the south side of the building forms a curved façade at the south face.

In addition to the elegant architecture and classic engineering, Torre Mayor is an intelligent building. The elevators have a seismic detector that detects any movement of earth and therefore automatically stops the elevator nearest to allow passengers to get off. The Torre Mayor is administered by the Building Management System (BMS), an intelligent system that controls all facilities and equipment harmoniously and efficiently to protect human life from danger.

Overall design of the structure

The innovative approach taken in the seismic design of Torre Mayor embraces a performance-based criterion, which is becoming the standard of advanced seismic design. This criterion is concerned not only with the final safety of the building in an event of a strong earthquake, but it also expects the building to be operational after a strong earthquake.

The building's superstructure is a combination of steel and concrete. The columns at the interior and perimeter of the tower are encased in reinforced concrete for the lower half of the tower. Typical floor framing is comprised of 75 mm thick composite metal deck with 50 mm of concrete supported on steel framing connected via shear-studs, except at the mechanical floor, where thicker slabs are used. The selected structural system is based on a redundant multiple system. This is accomplished by introducing a dual conventional (deflection sensitive) lateral-force resisting system in combination with a supplementary damping system (velocity sensitive).

“ This structure is known to be the only skyscraper in the world that has not had any major accidents or deaths during construction. ”

In effect, a “trio” system, composed of a primary braced frame at the perimeter of the tower coupled with a perimeter moment frame, forms an HSS system, and a trussed HSS at the core of the building is provided to respond to the seismic energy from an earthquake. The bracing connecting the composite core columns creates a structural spine in the building core. The perimeter frame and the powerful super-diagonal system create an efficient HSS structure, joining the spine in resisting the seismic forces. This system is augmented by the supplemental viscous dampers that are highly effective in reducing the impact of seismic motion on both the structure and the non-structural elements. The system reduces the overall and inter-story sway of the tower, as well as the vibration and the seismic forces of the structural elements.

“ This system is augmented by the supplemental viscous dampers that are highly effective in reducing the impact of seismic motion on both the structure and the non-structural elements. ”

Seismic design of the structure – design and implementation of fluid dampers

A combination caisson and mat system was selected for the foundation of the tower. The reinforced concrete mat system connected a series of caissons of up to 1.2 meter diameter, reaching down only 40 meter into a rubble layer below the soft surface soil. The concrete mat thickness varies from 1 meter to 2 meter in thickness and ties together the caissons and the 0.8 meter thick foundation walls.

Addition of viscous dampers to the structure was resorted to reduce structural stress during seismic loadings. The underlying design concept was to use the dampers to reduce stress, then lighten the building frame by removing steel until the stress crept up to the allowable limit of the code. Conceptually, the steel that had been “removed” by this process was then used to add additional floors. For the Torre Mayor, inherent structural damping in the frame was assumed to be 1% of critical. Multiple computer runs were made with added fluid damping in 2% increments. The approach used was to add damping until a lightweight 55 story building would result or until damping reached a value of 30% critical, at which the peak stresses would begin to increase. When the added damping in the structure reached 10% critical the resulting maximum height structure was calculated to be 55 floors. The structural detailing of the new tower could begin, having achieved the goals of the building’s owner for a 55 storied structure.

The first step in the design process of damper implementation involved an extensive structural analysis to determine the desired overall damping level. The number of dampers and damper sizes were roughly

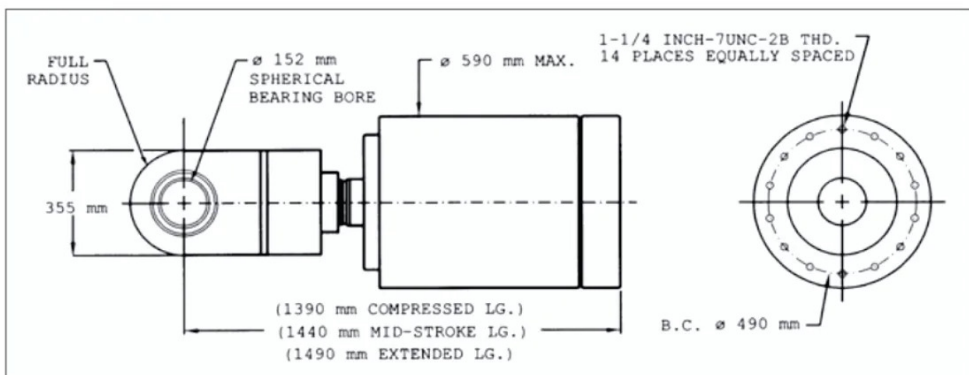

Fig. 1: 570 TONNES FORCE FLUID VISCOUS DAMPER

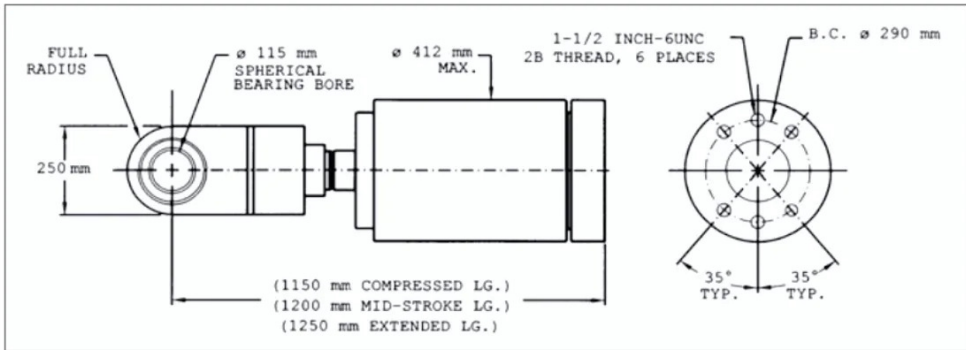

Fig. 2: 280 TONNES FORCE FLUID VISCOUS DAMPER



Fig. 3: Building frame during construction

estimated at this point to balance the cost of the dampers vs. the overall performance and cost of the structure. After the desired level of performance was achieved, the next step in the design process was to adjust the number of dampers and damper sizes against the available mounting locations in the structure and the desired architectural configuration. The third step in the design and implementation process was to optimize the performance of the individual dampers within the structure by varying the damping coefficients and exponents. A total of twenty-four large dampers of 570 tons rated force (Fig. 1) in the long walls of the structure and seventy-four pieces of a smaller 280 tons rated force dampers were used in the short walls of the structure (Fig. 2). Each damper spans over multiple floors, using a so-called “mega brace” element, installed in a diamond pattern. Fig. 3 indicates the building frame taken during construction which illustrates the diamond arrangement of the installed large dampers in their mega brace elements.



Fig.4: Damper installation

On January 21, 2003, the coastal region of the State of Colima, Mexico experienced a 7.6 magnitude earthquake. This earthquake affected a very large land area, including the nearby Mexican States of Jalisco and Michoacan, including the entire Mexico City area. Even though the epicenter of the quake was in an area of low population, damage was extensive. More than 13,000 residential structures and 600 commercial structures reported damage. Of these, more than 2,700 structures were totally destroyed. When the quake reached Mexico City it was amplified by the soft soils in the area. This resulted in a relatively strong response with some 30 seconds of shaking. At the time of the quake, 31 floors of the building were occupied, while the balance were still undergoing final interior finishing. Post-earthquake inspection was performed and there was no evidence of damage in the structure.

The Torre Mayor's design was again put to the test during the 2017 Puebla earthquake. It was a 7.1 magnitude event that

caused significant damage throughout Mexico City. However, no structural damage reported for the building. The state-of-the-art engineering ensured that the occupants were safe, and operations within the building were uninterrupted.

Conclusion

The Torre Mayor is not just a landmark in Mexico City; it is a benchmark for earthquake-resistant design worldwide. As urbanization continues to accelerate in seismically active areas around the globe, the Torre Mayor stands as a model for future high-rise constructions. It demonstrates that with thoughtful design and advanced technology, it is possible to build structures that not only reach for the sky but also offer unparalleled safety and resilience against the most adverse loading conditions.

REFERENCES

1. <https://www.slideshare.net/slideshow/earthquake-resistant-building-in-mexico/238885422>
2. <https://www.structuremag.org/?p=14181>
3. <https://www.scribd.com/presentation/353224979/EARTHQUAKE-RESISTANT-BUILDINGS-CASE-STUDIES-Yokohama-Landmark-Tower-Burj-Khalifa-Torre-Mayor-Mexico>
4. <https://youtu.be/MjKXuaPPK24?feature=shared>
5. <https://www.skyscrapercenter.com/building/torre-mayor/1185>
6. How Skyscrapers in Mexico City Withstand Earthquakes | Britannica
7. STRUCTURE magazine | Structural Design Challenges for Tall Buildings in Mexico City
8. Torre Mayor - Wikipedia
9. corporate express.qxd (aisc.org)
10. C:\Lorrie's Documents\Documents\Reports & Technical Papers\Symposium\74th Symposium\Mega Brace Seismic Dampers-PDF Version.PDF (teratec.ca)
11. untitled (taylordevices.com)





THE SEISMIC SHIFT

Seismic Academy Annual Conference 2024

EVENT DETAILS

- **Date** - 4th September 2024, Wednesday
- **Time** - 10:00 AM - 4:00 PM (IST)
- **Venue** - Gulmohar Hall, India Habitat Center, Lodhi Estate, New Delhi
- **To Register,**
Scan the QR Code





To View Conference 2022, Please Visit

<https://theseismicacademy.com/event-detail/seismic-academy-conference>



To View Conference 2023, Please Visit

<https://theseismicacademy.com/event-detail/seismic-resilient-infrastructure-in-health-care-facilities---annual-conference-2023>

Vol. 06
July 2024



**SEISMIC
ACADEMY**

“An earthquake is a reminder of the need for preparedness and the importance of being ready for any emergency.”

- Emmanuel Marcon



**FOR MORE DETAILS ON THIS INITIATIVE,
PLEASE VISIT OUR WEBSITE**

<https://theseismicacademy.com>